

EMX-SKLUP

Intel® 6th Generation ULT Processor Thin Mini ITX
Motherboard

User's Manual

4th Ed – 25 January 2022

FCC Statement



THIS DEVICE COMPLIES WITH PART 15 FCC RULES. OPERATION IS SUBJECT TO THE FOLLOWING TWO CONDITIONS:

- (1) THIS DEVICE MAY NOT CAUSE HARMFUL INTERFERENCE.
- (2) THIS DEVICE MUST ACCEPT ANY INTERFERENCE RECEIVED INCLUDING INTERFERENCE THAT MAY CAUSE UNDESIRE OPERATION.

THIS EQUIPMENT HAS BEEN TESTED AND FOUND TO COMPLY WITH THE LIMITS FOR A CLASS "A" DIGITAL DEVICE, PURSUANT TO PART 15 OF THE FCC RULES.

THESE LIMITS ARE DESIGNED TO PROVIDE REASONABLE PROTECTION AGAINST HARMFUL INTERFERENCE WHEN THE EQUIPMENT IS OPERATED IN A COMMERCIAL ENVIRONMENT. THIS EQUIPMENT GENERATES, USES, AND CAN RADIATE RADIO FREQUENCY ENERGY AND, IF NOT INSTALLED AND USED IN ACCORDANCE WITH THE INSTRUCTION MANUAL, MAY CAUSE HARMFUL INTERFERENCE TO RADIO COMMUNICATIONS.

OPERATION OF THIS EQUIPMENT IN A RESIDENTIAL AREA IS LIKELY TO CAUSE HARMFUL INTERFERENCE IN WHICH CASE THE USER WILL BE REQUIRED TO CORRECT THE INTERFERENCE AT HIS OWN EXPENSE.

Notice

This guide is designed for experienced users to setup the system within the shortest time. For detailed information, please always refer to the electronic user's manual.

Copyright Notice

Copyright © 2022 Avalue Technology Inc., ALL RIGHTS RESERVED.

No part of this document may be reproduced, copied, translated, or transmitted in any form or by any means, electronic or mechanical, for any purpose, without the prior written permission of the original manufacturer.

Trademark Acknowledgement

Brand and product names are trademarks or registered trademarks of their respective owners.

Disclaimer

Avalue Technology Inc. reserves the right to make changes, without notice, to any product, including circuits and/or software described or contained in this manual in order to improve design and/or performance. Avalue Technology assumes no responsibility or liability for the use of the described product(s), conveys no license or title under any patent, copyright, or masks work rights to these products, and makes no representations or warranties that

these products are free from patent, copyright, or mask work right infringement, unless otherwise specified. Applications that are described in this manual are for illustration purposes only. Avalue Technology Inc. makes no representation or warranty that such application will be suitable for the specified use without further testing or modification.

Life Support Policy

Avalue Technology's PRODUCTS ARE NOT FOR USE AS CRITICAL COMPONENTS IN LIFE SUPPORT DEVICES OR SYSTEMS WITHOUT THE PRIOR WRITTEN APPROVAL OF Avalue Technology Inc.

As used herein:

1. Life support devices or systems are devices or systems which, (a) are intended for surgical implant into body, or (b) support or sustain life and whose failure to perform, when properly used in accordance with instructions for use provided in the labeling, can be reasonably expected to result in significant injury to the user.
2. A critical component is any component of a life support device or system whose failure to perform can be reasonably expected to cause the failure of the life support device or system, or to affect its safety or effectiveness.

A Message to the Customer

Avalue Customer Services

Each and every Avalue's product is built to the most exacting specifications to ensure reliable performance in the harsh and demanding conditions typical of industrial environments. Whether your new Avalue device is destined for the laboratory or the factory floor, you can be assured that your product will provide the reliability and ease of operation for which the name Avalue has come to be known.

Your satisfaction is our primary concern. Here is a guide to Avalue's customer services. To ensure you get the full benefit of our services, please follow the instructions below carefully.

Technical Support

We want you to get the maximum performance from your products. So if you run into technical difficulties, we are here to help. For the most frequently asked questions, you can easily find answers in your product documentation. These answers are normally a lot more detailed than the ones we can give over the phone. So please consult the user's manual first.

To receive the latest version of the user's manual; please visit our Web site at:

<http://www.avalue.com.tw/>

EMX-SKLUP User's Manual

Product Warranty

Avalue warrants to you, the original purchaser, that each of its products will be free from defects in materials and workmanship for two years from the date of purchase.

This warranty does not apply to any products which have been repaired or altered by persons other than repair personnel authorized by Avalue, or which have been subject to misuse, abuse, accident or improper installation. Avalue assumes no liability under the terms of this warranty as a consequence of such events. Because of Avalue's high quality-control standards and rigorous testing, most of our customers never need to use our repair service. If any of Avalue's products is defective, it will be repaired or replaced at no charge during the warranty period. For out-of-warranty repairs, you will be billed according to the cost of replacement materials, service time, and freight. Please consult your dealer for more details. If you think you have a defective product, follow these steps:

1. Collect all the information about the problem encountered. (For example, CPU type and speed, Avalue's products model name, hardware & BIOS revision number, other hardware and software used, etc.) Note anything abnormal and list any on-screen messages you get when the problem occurs.
2. Call your dealer and describe the problem. Please have your manual, product, and any helpful information available.
3. If your product is diagnosed as defective, obtain an RMA (return material authorization) number from your dealer. This allows us to process your good return more quickly.
4. Carefully pack the defective product, a complete Repair and Replacement Order Card and a photocopy proof of purchase date (such as your sales receipt) in a shippable container. A product returned without proof of the purchase date is not eligible for warranty service.
5. Write the RMA number visibly on the outside of the package and ship it prepaid to your dealer.

Content

1. Getting Started	8
1.1 Safety Precautions	8
1.2 Packing List.....	8
1.3 Document Amendment History	9
1.4 Manual Objectives.....	10
1.5 System Specifications	11
1.6 Architecture Overview—Block Diagram	15
2. Hardware Configuration	16
2.1 Product Overview.....	17
2.2 Jumper and Connector List.....	19
2.3 Setting Jumpers & Connectors	22
2.3.1 Serial port 1/2/3/4/5/6 pin9 signal select (JRI1/JRI2/JRI3/JRI4/JRI5/JRI6)	22
2.3.2 LVDS Back Light power selection (JSBKL1).....	22
2.3.3 AT/ATX Power Mode Select (JSATX1).....	23
2.3.4 Clear CMOS (JCOMS1).....	23
2.3.5 LCD Inverter connector (JBKL1).....	24
2.3.6 General purpose I/O connector (DIO1).....	24
2.3.7 Serial port 1/2 connector (COM1/2).....	25
2.3.8 Serial port 3/4/5/6 connector (COM3/4/5/6).....	25
2.3.9 Serial Port 1/2 RS485/422 Mode connector (JRS485_1/2).....	26
2.3.10 SATA Power connector 1/2 (SPWR1/2).....	26
2.3.11 Power connector (PWR1).....	27
2.3.12 USB connector 3 (USB3).....	27
2.3.13 USB connector 4 (USB4).....	28
2.3.14 Battery connector (BT1).....	28
2.3.15 LVDS connector (LVDS1).....	29
2.3.16 Audio connector (FAUD1).....	30
2.3.17 EC Debug (JEC_SPI).....	30
2.3.18 SPI connector (JSPI1).....	31
2.3.19 Sony/Philips Digital Interface (SPDIF1).....	31
2.3.20 Miscellaneous setting connector 1 (FPT1).....	32
2.3.21 Miscellaneous setting connector 2 (FPT2).....	32
2.3.22 LED indicator connector 1 (LED1).....	33
2.3.23 LED indicator connector 2 (LED2).....	33
2.3.24 Speaker connector (SPK1).....	34
2.3.25 Mic-in connector (DMIC1).....	34

EMX-SKLUP User's Manual

2.3.26	I2C connector (I2C1)	35
2.3.27	eDP_Panel connector (EDP1).....	35
2.3.28	LPC connector (JLPC).....	36
2.3.29	CPU fan connector (FAN1).....	36
2.3.30	HDMI1/DP1/DP2/LVDS1	37
3	BIOS Setup	38
3.1	Introduction	39
3.2	Starting Setup	39
3.3	Using Setup	40
3.4	Getting Help.....	41
3.5	In Case of Problems.....	41
3.6	BIOS setup.....	42
3.6.1	Main Menu.....	42
3.6.1.1	System Language.....	43
3.6.1.2	System Date	43
3.6.1.3	System Time.....	43
3.6.2	Advanced Menu	43
3.6.2.1	Trusted Computing	44
3.6.2.2	ACPI Settings	44
3.6.2.3	AMT Configuration.....	45
3.6.2.4	PCH-FW Configuration	46
3.6.2.4.1	Firmware Update Configuration.....	46
3.6.2.5	IT8528 Super IO Configuration.....	47
3.6.2.5.1	Serial Port 1 Configuration	48
3.6.2.5.2	Serial Port 2 Configuration	48
3.6.2.5.3	Serial Port 3 Configuration	49
3.6.2.5.4	Serial Port 4 Configuration	49
3.6.2.5.5	Serial Port 5 Configuration	50
3.6.2.5.6	Serial Port 6 Configuration	50
3.6.2.6	H/W Monitor.....	51
3.6.2.6.1	Smart Fan Mode Configuration	51
3.6.2.7	S5 RTC Wake Settings.....	52
3.6.2.8	Serial Port Console Redirection	53
3.6.2.8.1	COM1	54
3.6.2.9	CPU Configuration.....	56
3.6.2.10	Intel TXT Information	57
3.6.2.11	SATA Configuration.....	58
3.6.2.12	Network Stack Configuration	59
3.6.2.13	CSM Configuration	60
3.6.2.14	SDIO Configuration	61

3.6.2.15	USB Configuration	61
3.6.3	Chipset.....	63
3.6.3.1	System Agent (SA) Configuration	63
3.6.3.1.1	Graphics Configuration	64
3.6.3.1.2	Memory Configuration	65
3.6.3.2	PCH-IO Configuration	66
3.6.3.2.1	PCI Express Configuration	66
3.6.3.2.2	USB Configuration	72
3.6.3.2.3	HD Audio Configuration	72
3.6.3.2.4	SCS Configuration	73
3.6.4	Security.....	74
3.6.4.1	Secure Boot menu	75
3.6.4.1.1	Key Management.....	76
3.6.5	Boot	76
3.6.6	Save and exit.....	77
3.6.6.1	Save Changes and Reset.....	77
3.6.6.2	Discard Changes and Reset.....	77
3.6.6.3	Restore Defaults	77
3.6.6.4	Launch EFI Shell from filesystem device	77
4.	Drivers Installation.....	78
4.1	Install Chipset Driver	79
4.2	Install VGA Driver.....	80
4.3	Install Serial IO Driver	81
4.4	Install ME Driver	82
4.5	Install Audio Driver (For Realtek ALC888S HD Audio).....	83
4.6	Install LAN Driver	84
4.7	Install RST Driver	86
5.	Mechanical Drawing	88

1. Getting Started

1.1 Safety Precautions

Warning!



Always completely disconnect the power cord from your chassis whenever you work with the hardware. Do not make connections while the power is on. Sensitive electronic components can be damaged by sudden power surges. Only experienced electronics personnel should open the PC chassis.

Caution!



Always ground yourself to remove any static charge before touching the CPU card. Modern electronic devices are very sensitive to static electric charges. As a safety precaution, use a grounding wrist strap at all times. Place all electronic components in a static-dissipative surface or static-shielded bag when they are not in the chassis.

1.2 Packing List

Before you begin installing your single board, please make sure that the following materials have been shipped:

- 1 x EMX-SKLUP motherboard
- 1 x SATA cable
- 1 x SATA power cable
- 1 x I/O Shield



If any of the above items is damaged or missing, contact your retailer.

1.3 Document Amendment History

Revision	Date	By	Comment
1 st	February 2017	Avalue	Initial Release
2 nd	September 2017	Avalue	Update Setting Jumpers & Connectors
3 rd	April 2018	Avalue	Update System Specifications and Setting Jumpers & Connectors
4 th	January 2022	Avalue	Update System Specifications

1.4 Manual Objectives

This manual describes in details Avalue Technology EMX-SKLUP Single Board.

We have tried to include as much information as possible but we have not duplicated information that is provided in the standard IBM Technical References, unless it proved to be necessary to aid in the understanding of this board.

We strongly recommend that you study this manual carefully before attempting to set up EMX-SKLUP or change the standard configurations. Whilst all the necessary information is available in this manual we would recommend that unless you are confident, you contact your supplier for guidance.

Please be aware that it is possible to create configurations within the CMOS RAM that make booting impossible. If this should happen, clear the CMOS settings, (see the description of the Jumper Settings for details).

If you have any suggestions or find any errors regarding this manual and want to inform us of these, please contact our Customer Service department with the relevant details.

1.5 System Specifications

System	
CPU	Onboard 6th Gen Intel® Core™ SoC i7/i5/i3 & Celeron®BGA Processor
BIOS	AMI uEFI BIOS, 128Mbit SPI Flash ROM
I/O Chip	EC IT8528E
System Memory	Two 260-pin DDR4 2133 MHz SO-DIMM socket, supports up to 32GB Max (non ECC only)
Watchdog Timer	H/W Reset, 1sec. – 65535sec./min.1sec. or 1min. step
EEPROM	AMI uEFI BIOS, 128Mbit SPI Flash ROM
H/W Status Monitor	CPU temperature monitoring Voltages monitoring CPU fan speed control
Expansion	1 x M.2 Type B 3042/2242/2260/2280 (with 2 x PCI-e x 1 (default) or 1 x PCI-e x 2 (By OEM BIOS ME SET), USB 2.0, USB3.0, SATA Signal) with 1 x SIM card slot, support WWAN+GNSS or SSD with 1 x SIM card slot, support WWAN+GNSS or SSD. 1 x M.2 Type A 2230 support WiFi module, 1 x PCI-e x 1, USB 2.0 Signal) 1 x SD card slot support SDXC/ SDHC 3.0 Card 1 x PCI-e x 1
S3/S4	Yes (S0/S3/S4/S5)
I/O	
USB	4 x USB 3.0, 4 x USB 2.0
GPIO	16-bits GPIO
Display	
Chipset	Intel® Processor Graphics
Resolution	1 x HDMI 1.4b: 3840 x 2160 @ 30 Hz, 2560 x 1600@ 30 Hz 2 x DP: DisplayPort 1.2a : 4096x2160 @ 60Hz (1 x HDMI/DP, 1 x DP++) 2CH 18/24bits LVDS 1920 x 1080 (Chrontel. CH7511B eDP to LVDS Converter) Co-lay eDP 1.3: 4096x2160 BOM optional
Multiple Display	Triple Display
Display	1 x DP++, 1 x HDMI/DP, 1 x HDMI
LCD Interface	Dual channel 18/24-bits LVDS (Chrontel CH7511B eDP to LVDS) or eDP (optional)
Audio	
AC97 Codec	Realtek ALC888S HD Audio Decoding Controller
Audio Amp	TI TPA3113D2PWP Stereo Class-D 6W x 2
Ethernet	
LAN Chip	1 x Intel® I219LM Gigabit Ethernet PHY

EMX-SKLUP User's Manual

	1 x Intel® I211AT PCI-e Gigabit Ethernet
Ethernet Interface	Gigabit Ethernet
Internal I/O Connectors	
Fan	1 x 1 x 4 pin, pitch 2.54mm CPU fan connector with smart fan function supported
System 1 I2C	1 x 1 x 5 pin, pitch 2.00mm, +3.3S Level
Buzzer	Onboard
CMOS Battery	1 x horizontal type battery connector (Battery cable 170mm length)
Power ON	1 x 2 x 5 pin, pitch 2.54mm connector for front panel 1 1 x 2 x 5 pin, pitch 2.54mm connector for front panel 2
Audio	1 x 2 x 5 pin, pitch 2.54mm connector for front Audio
External I/O Connector	<p>Storage:</p> <p>1 x M.2 Type B 3042/2242/2260/2280 (with 2 x PCI-e x 1 (default) or 1 x PCI-e x 2 (By OEM BIOS ME SET), USB 2.0, USB3.0, SATA Signal) with 1 x SIM card slot, support WWAN+GNSS or SSD.</p> <p>1 x M.2 Type A 2230 support WiFi module, 1 x PCI-e x 1, USB 2.0 Signal)</p> <p>- 2 x SATA III</p> <p>- 2 x SATA power connectors</p> <p>COM:</p> <p>COM 1 & COM2</p> <p>-COM 1 & COM2 support RS232/422/485 connector, with / +5V & +12V Supported and RS422/485 by BIOS setting</p> <p>2 x 2 x 5 pin, pitch 2.00mm connector for COM1: support RS-232 connector, Pin 9 with / +5V & +12V Supported</p> <p>2 x 2 x 3 pin, pitch 2.00mm connector for COM1: support RS422/485 connector, Pin 5 with / +5V Supported</p> <p>COM3~6:</p> <p>- 4 x 2 x 5 pin, pitch 2.00mm connector for COM2~6: support RS-232 connector, Pin 9 with / +5V & +12V Supported</p> <p>2 x 2 x 5 pin, pitch 2.54mm connector for 4 USB 2.0</p> <p>1 x 2 x 10 pin, pitch 2.00mm connector for GPIO: 16 bits & +3.3S Level SMBus</p> <p>1 x 2 x 4 pin, pitch 2.00mm connector for BIOS SPI</p> <p>1 x 2 x 5 pin, pitch 2.00mm connector for EC SPI</p> <p>1 x 2 x 5 pin, pitch 2.0mm connector for LPC</p> <p>1 x horizontal type battery connector (Battery cable 170mm length)</p> <p>1 x 2 x 5 pin, pitch 2.54mm connector for front panel 1</p> <p>1 x 2 x 5 pin, pitch 2.54mm connector for front panel 2</p> <p>1 x 2 x 20 pin, pitch 1.25mm connector for LVDS (must be using WF40H6-7GAA178 connector)</p> <p>1 x 2 x 10 pin, pitch 1.25mm connector for eDP</p>

	<p>1 x 1 x 5 pin, pitch 2.00mm Wafer connector for LCD inverter backlight connector (5V/12V)</p> <p>1 x 1 x 3 pin, pitch 2.54mm connector LCD backlight brightness adjustment (PWM/DC)</p> <p>1 x 2 x 5 pin, pitch 2.54mm connector for front Audio</p> <p>1 x 3 pin, pitch 2.54mm connector for S/PDIF</p> <p>1 x 4 pin, pitch wafer 2.00mm connector for 6W x 2 Speaker</p> <p>1 x 3 pin, pitch 2.00mm connector for CMOS clear</p> <p>1 x 1 x 4 pin, pitch 2.54mm CPU fan connector with smart fan function supported</p> <p>2 x 1 x 4 pin, pitch 2.00mm connector for LAN Activity Indicator LED</p> <p>1 x 1 x 5 pin, pitch 2.54mm for Digital MIC in</p> <p>1 x 2 x 2 pin, pitch 4.20mm connector for power input connector</p> <p>1 x 1 x 3 pin, pitch 2.54mm connector for AT/ATX mode Fanless Operating</p>
Rear I/O Connectors	
USB	4 x USB3.0
LAN	<p>1 x Intel® I219LM Gigabit Ethernet PHY</p> <p>1 x Intel® I211AT PCI-e Gigabit Ethernet</p>
Display	1 x DP++, 1 x HDMI/DP
LED	2 x 1 x 4 pin, pitch 2.00mm connector for LAN Activity Indicator LED
Rear Side External I/O Connector	<p>2 x RJ-45</p> <p>4 x USB 3.0</p> <p>1 x HDMI/DP</p> <p>1 x HDMI</p> <p>1 x DP++</p> <p>1 x Mic-In and 1 x Line-out</p> <p>1 x DC Jack lockable connector type</p>
Mechanical & Environmental	
Power Requirement	DC in +12V~24V
ACPI	<p>Single power ATX Support S0, S3, S4, S5</p> <p>ACPI 5.0 Compliant</p>
Power Type	AT / ATX mode Switchable Through Jumper
Operating Temp.	0 ~ 60°C (32~140°F)
Storage Temp.	-40 ~ +75°C
Operating Humidity	0% ~ 90% relative humidity, non-condensing
Size (L x W)	6.7" x 6.7" (170mm x 170mm)
Weight	0.40 kg

EMX-SKLUP User's Manual



Note:

Specifications are subject to change without notice.

1.6 Architecture Overview—Block Diagram

The following block diagram shows the architecture and main components of EMX-SKLUP.

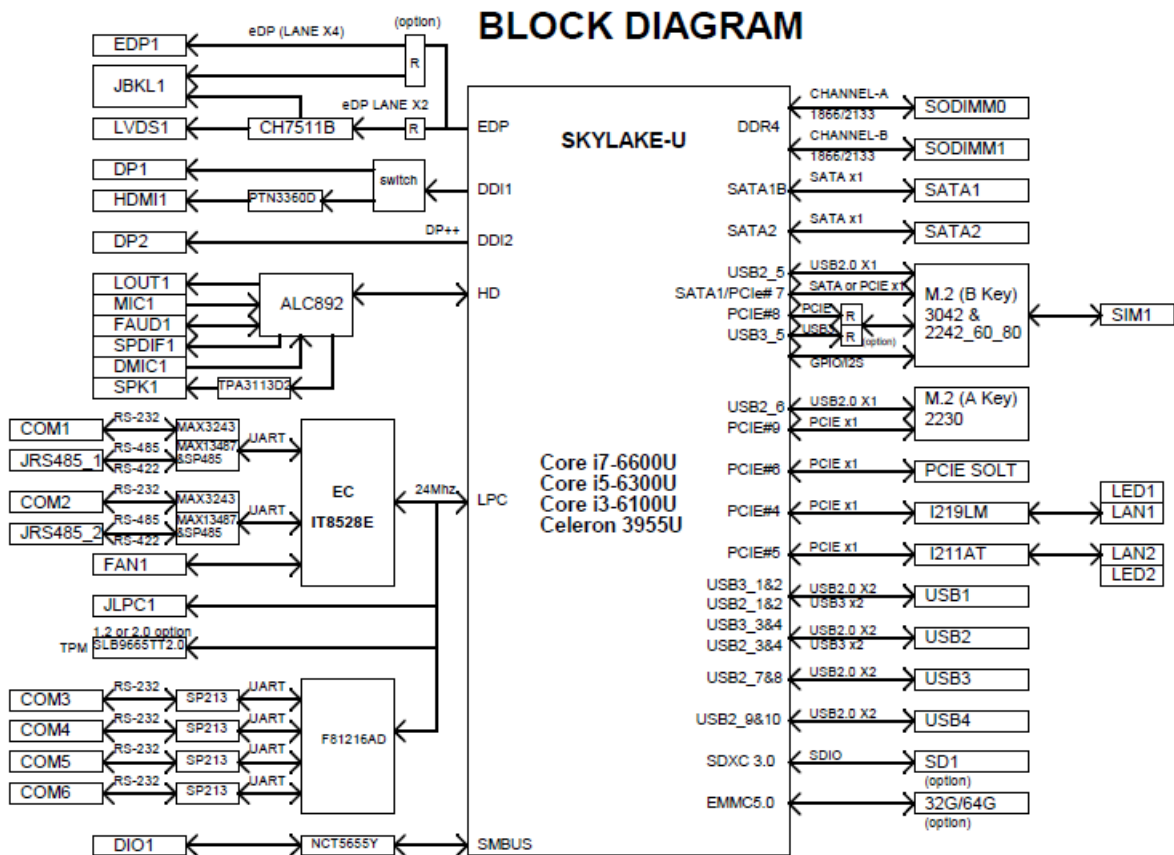

2. Hardware Configuration

2.1 Product Overview

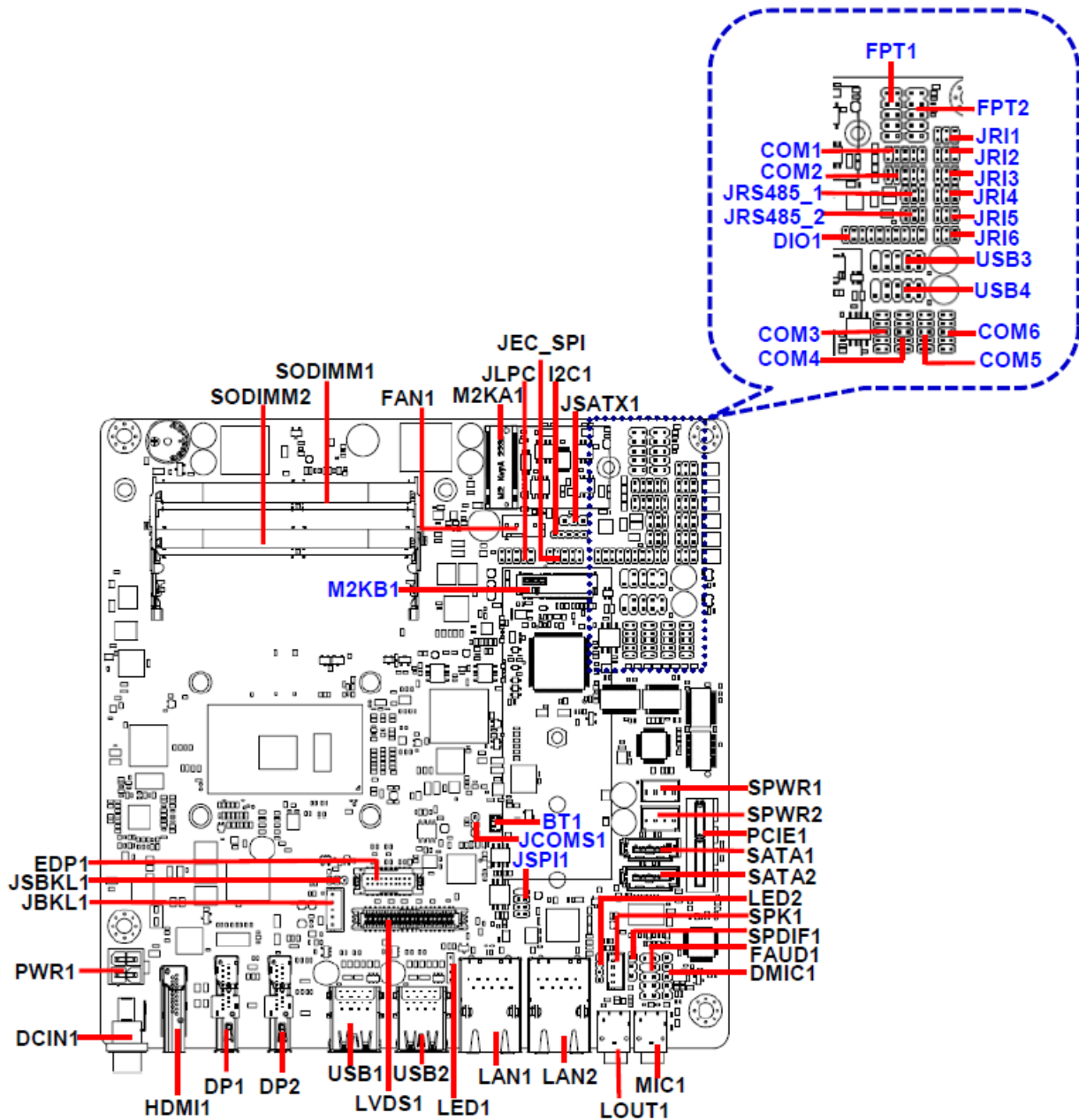

Note:

If M.2 Type B 3042/2242/2260/2280 using PCI-e x2 device, it requires OEM BIOS ME setting; hence PCI-e slot is not workable.

EMX-SKLUP User's Manual

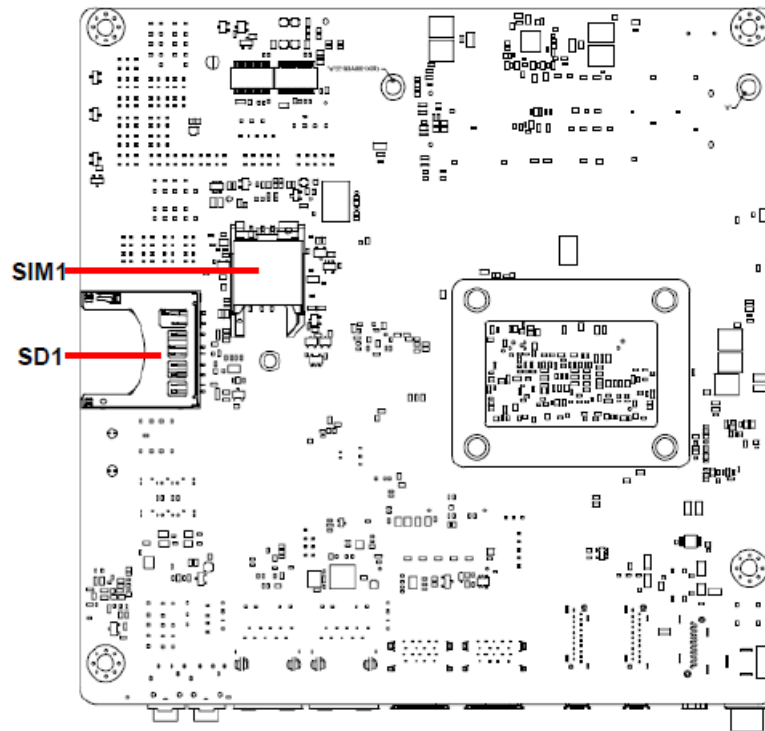

Note:

SD card support list please refer to HW Storage Compatibility Test report.

2.2 Jumper and Connector List

You can configure your board to match the needs of your application by setting jumpers. A jumper is the simplest kind of electric switch.

It consists of two metal pins and a small metal clip (often protected by a plastic cover) that slides over the pins to connect them. To “close” a jumper you connect the pins with the clip. To “open” a jumper you remove the clip. Sometimes a jumper will have three pins, labeled 1, 2, and 3. In this case, you would connect either two pins.

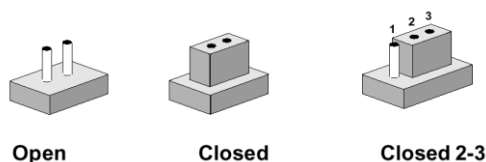

The jumper settings are schematically depicted in this manual as follows:



A pair of needle-nose pliers may be helpful when working with jumpers.

Connectors on the board are linked to external devices such as hard disk drives, a keyboard, or floppy drives. In addition, the board has a number of jumpers that allow you to configure your system to suit your application.

If you have any doubts about the best hardware configuration for your application, contact your local distributor or sales representative before you make any changes.

The following tables list the function of each of the board's jumpers and connectors.

Jumpers

Label	Function	Note
JRI1/2/3/4/5/6	Serial port 1/2/3/4/5/6 pin9 signal select	3 x 2 header, pitch 2.00mm
JSBKL1	LVDS Back Light power selection	3 x 1 header, pitch 2.00mm
JSATX1	AT/ATX Power Mode Select	3 x 1 header, pitch 2.54mm
JCOMS1	Clear CMOS	3 x 1 header, pitch 2.00mm

Connectors

Label	Function	Note
FPT1	Miscellaneous setting connector 1	5 x 2 header, pitch 2.54mm
FPT2	Miscellaneous setting connector 2	5 x 2 header, pitch 2.54mm
SODIMM1/2	206-pin DDR4 SO-DIMM socket	
FAUD1	Front Audio connector	5 x 2 header, pitch 2.54mm
JBKL1	LCD Inverter connector	5 x 1 wafer, pitch 2.00mm

EMX-SKLUP User's Manual

JSPI1	SPI connector	4 x 2 header, pitch 2.00mm
JEC_SPI	EC Debug	5 x 2 header, pitch 2.00mm
COM1	Serial Port 1 connector	5 x 2 header, pitch 2.00mm
COM2	Serial Port 2 connector	5 x 2 header, pitch 2.00mm
COM3	Serial Port 3 connector	5 x 2 header, pitch 2.00mm
COM4	Serial Port 4 connector	5 x 2 header, pitch 2.00mm
COM5	Serial Port 5 connector	5 x 2 header, pitch 2.00mm
COM6	Serial Port 6 connector	5 x 2 header, pitch 2.00mm
DIO1	General purpose I/O connector	10 x 2 header, pitch 2.00mm
SPK1	Speaker connector	4 x 1 wafer, pitch 2.00mm
LVDS1	LVDS Connector	20 x 2 wafer, pitch 1.25mm
USB1/2	USB connector 1/2	
USB3/4	USB connector 3/4	5 x 2 header, pitch 2.54mm
SPDIF1	Sony/Philips Digital Interface	3 x 1 header, pitch 2.54mm
LAN1/2	RJ-45 Ethernet 1/2	
PCIE1	PCIe connector	
LED1	LED indicator connector 1	4 x 1 header, pitch 2.00mm
LED2	LED indicator connector 2	4 x 1 header, pitch 2.00mm
BT1	Battery connector	2 x 1 wafer, pitch 1.25mm
M2KA1	M.2 2230 Type A Slot	
M2KB1	M.2 3042/2242/2260/2280 Type B Slot	
DP1/2	DP connector 1/2	
EDP1	eDP_Panel connector	10 x 2 wafer, pitch 1.25mm
JRS485_1/2	Serial Port 1/2 RS485/422 Mode connector	3 x 2 header, pitch 2.00mm
JLPC	LPC connector	5 x 2 header, pitch 2.00mm
DCIN1	DC Power-in connector	
PWR1	Power connector	2 x 2 wafer, pitch 4.20mm
SATA1/2	Serial ATA connector 1/2	
SPWR1/2	SATA Power connector 1/2	4 x 1 wafer, pitch 2.54mm
I2C1	I2C connector	5 x 1 header, pitch 2.00mm
HDMI1	HDMI connector	
LOUT1	Line-out audio jack	
MIC1	Mic-in audio jack	
DMIC1	Mic-in connector	5 x 1 header, pitch 2.54mm
SD1	SD card slot	

SIM1	SIM card slot	
FAN1	CPU fan connector	4 x 1 wafer, pitch 2.54mm

2.3 Setting Jumpers & Connectors

2.3.1 Serial port 1/2/3/4/5/6 pin9 signal select (JRI1/JRI2/JRI3/JRI4/JRI5/JRI6)

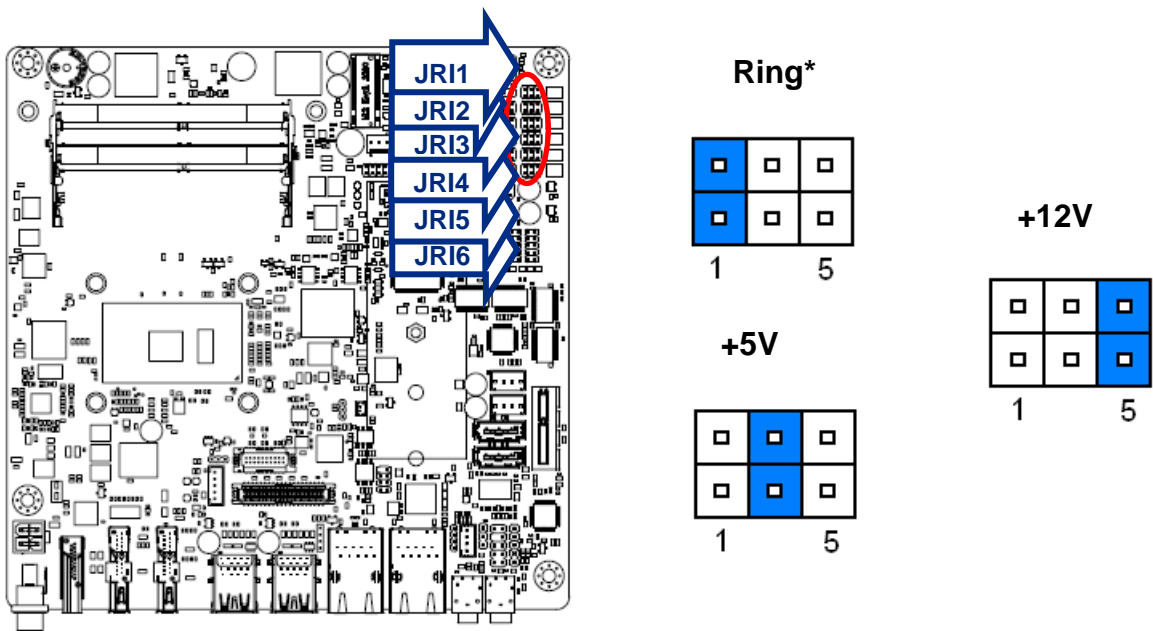

* Default

2.3.2 LVDS Back Light power selection (JSBKL1)

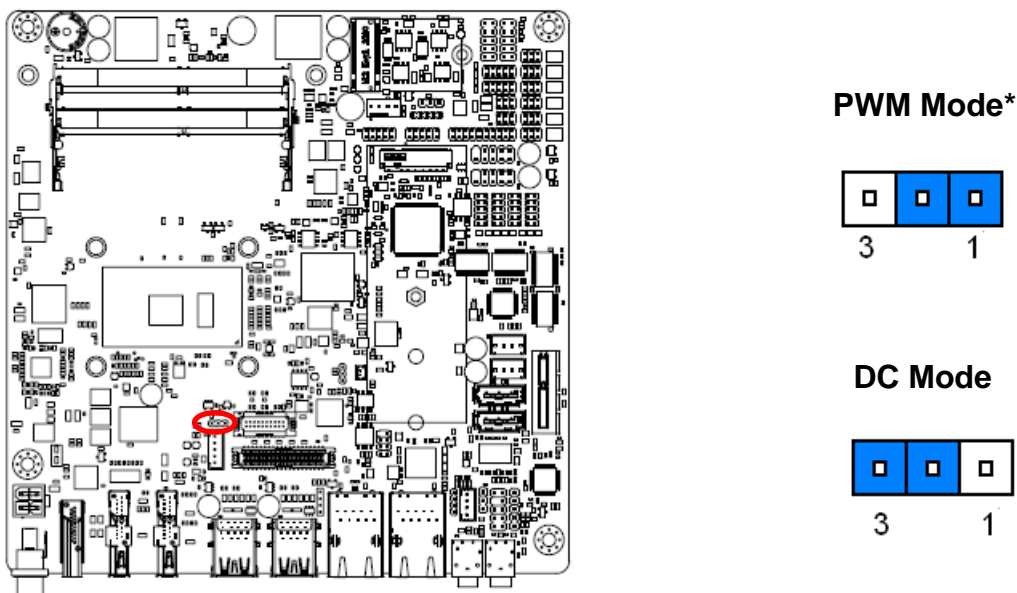

* Default

2.3.3 AT/ATX Power Mode Select (JSATX1)

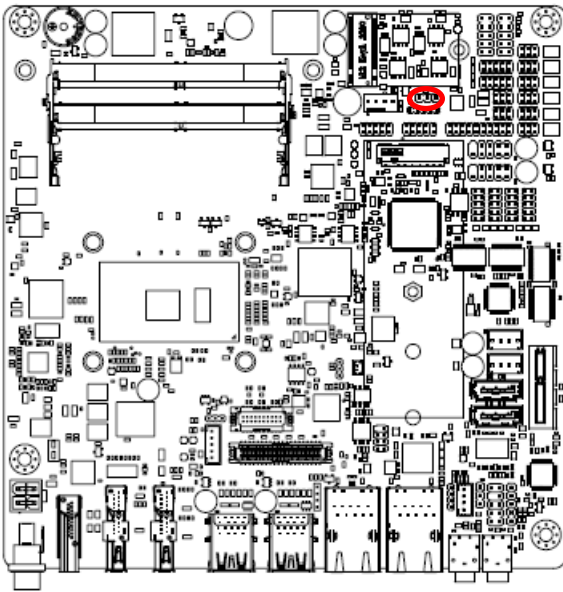

AT

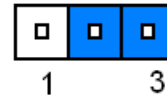

ATX*

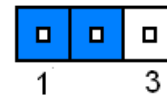

* Default

2.3.4 Clear CMOS (JCOMS1)

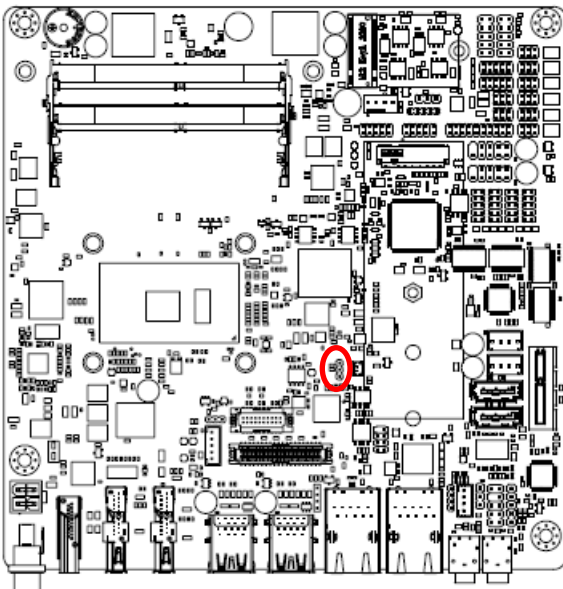

Protect*

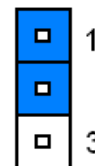

Clear CMOS

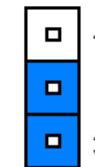

* Default

2.3.5 LCD Inverter connector (JBKL1)

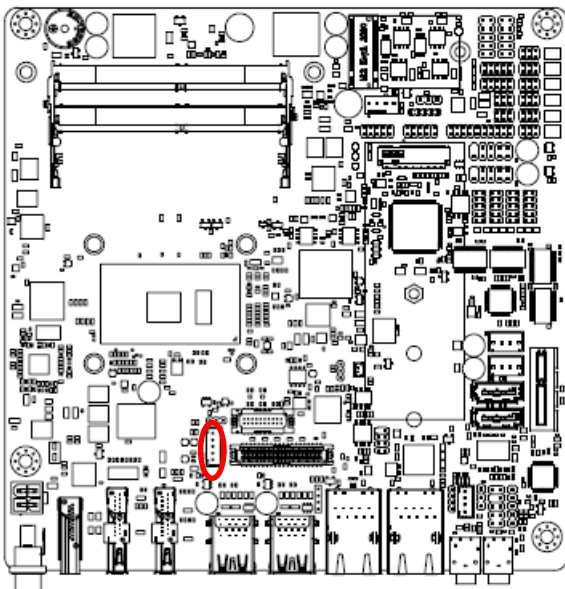

PIN	Signal	Max current
5	+5V	2A
4	LVDS_BKLTCTL	
3	LVDS_BKLT_EN	
2	GND	
1	+12V	2A

2.3.6 General purpose I/O connector (DIO1)

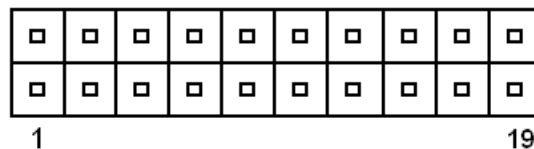
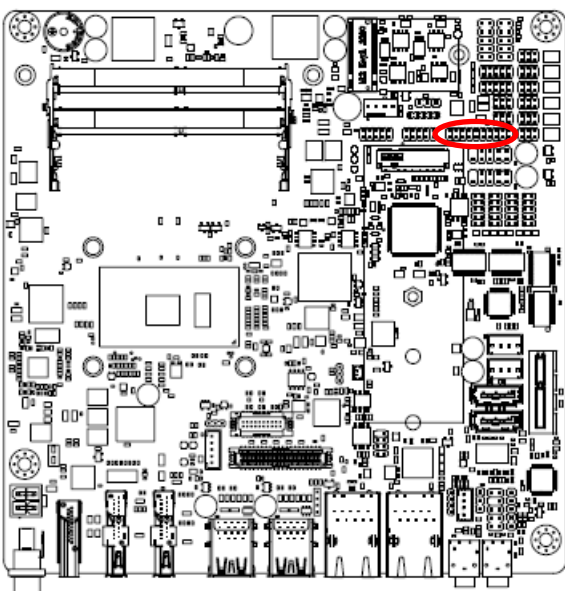

Signal	PIN	PIN	Signal
DI0	1	2	DO0
DI1	3	4	DO1
DI2	5	6	DO2
DI3	7	8	DO3
DI4	9	10	DO4
DI5	11	12	DO5
DI6	13	14	DO6
DI7	15	16	DO7
SMB_CLK_S	17	18	SMB_DATA_S
GND	19	20	+5V(Max current = 0.5A)

2.3.7 Serial port 1/2 connector (COM1/2)

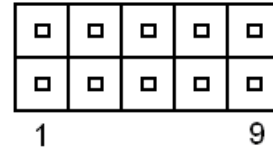
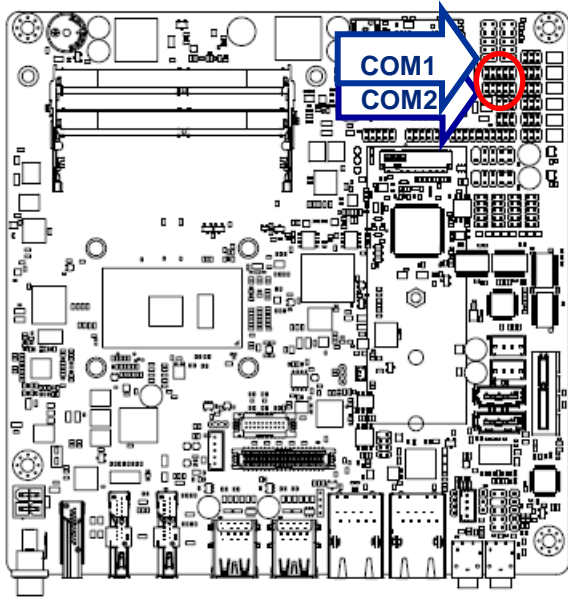

Signal	PIN	PIN	Signal
DCD	1	2	RXD
TXD	3	4	DTR
GND	5	6	DSR
RTS	7	8	CTS
RI (Max current = 0.5A)	9	10	NC

2.3.8 Serial port 3/4/5/6 connector (COM3/4/5/6)

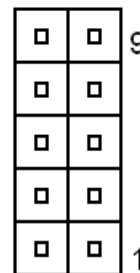
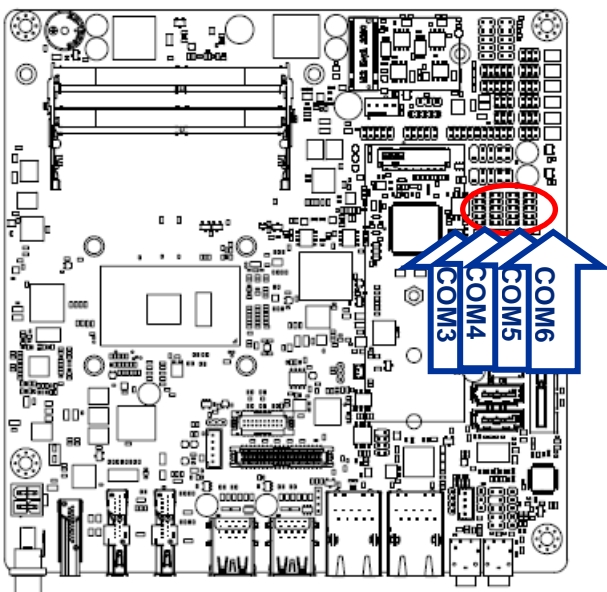

Signal	PIN	PIN	Signal
NC	10	9	RI (Max current = 0.5A)
CTS	8	7	RTS
DSR	6	5	GND
DTR	4	3	TXD
RXD	2	1	DCD

2.3.9 Serial Port 1/2 RS485/422 Mode connector (JRS485_1/2)

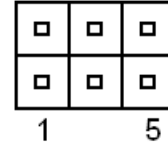
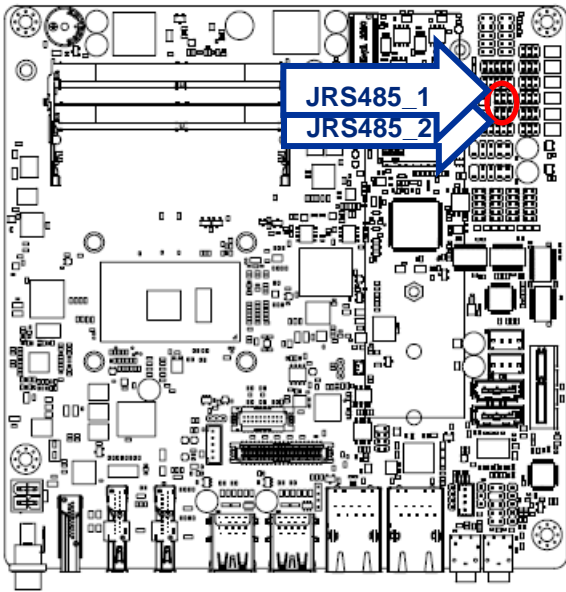

Signal	PIN	PIN	Signal
485_422TX-	1	2	422RX-
485_422TX+	3	4	422RX+
+5V (Max current = 0.5A)	5	6	GND

2.3.10 SATA Power connector 1/2 (SPWR1/2)

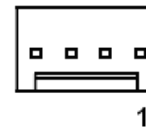
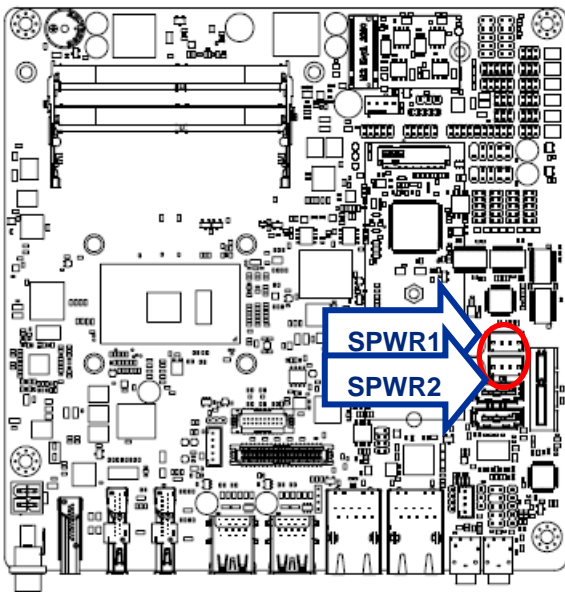

PIN	Signal	Max current
1	+V5S_SATA	1A
2	GND	
3	GND	
4	+V12S_SATA	1A

2.3.11 Power connector (PWR1)

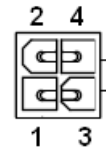
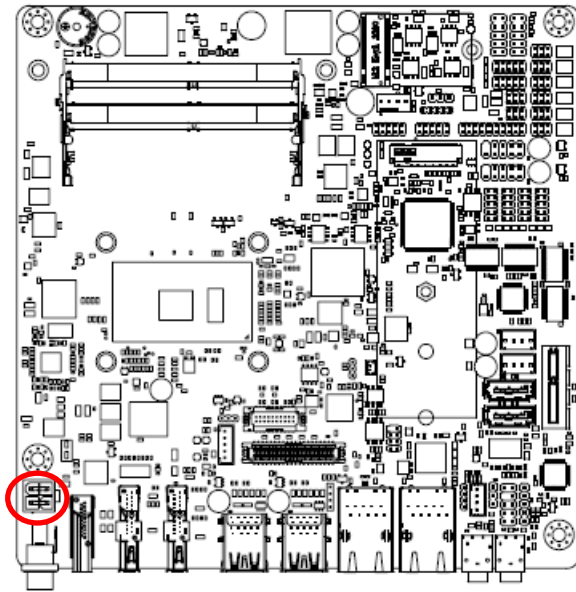

Signal	PIN	PIN	Signal
GND	2	4	+VIN
GND	1	3	+VIN

2.3.12 USB connector 3 (USB3)

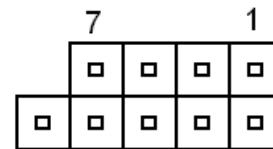
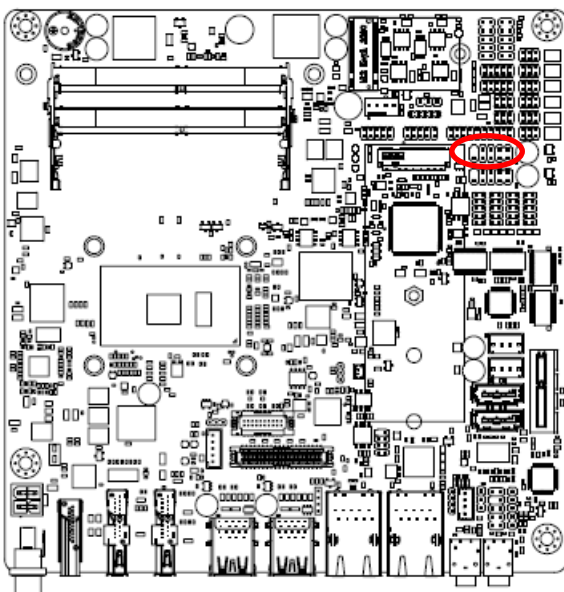

Signal	PIN	PIN	Signal
+V5A_USB78	1	2	+V5A_USB78
USB_DN7	3	4	USB_DN8
USB_DP7	5	6	USB_DP8
GND	7	8	GND
		10	NC

2.3.13 USB connector 4 (USB4)

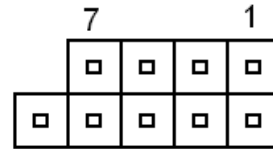
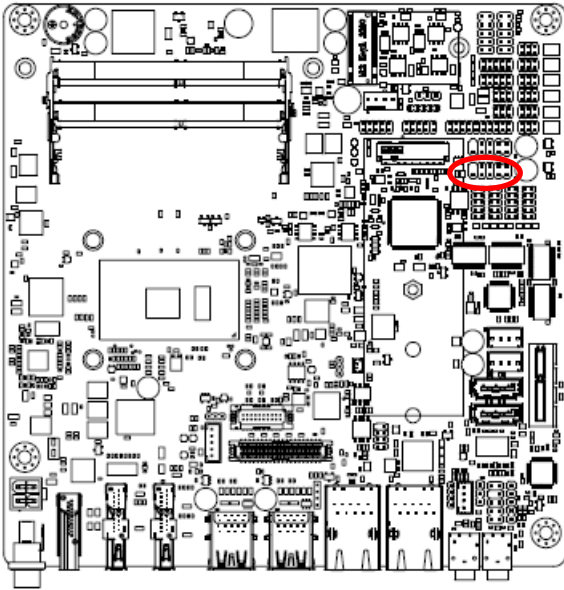

Signal	PIN	PIN	Signal
+V5A_USB78	1	2	+V5A_USB78
USB_DN9	3	4	USB_DN10
USB_DP9	5	6	USB_DP10
GND	7	8	GND
		10	NC

2.3.14 Battery connector (BT1)

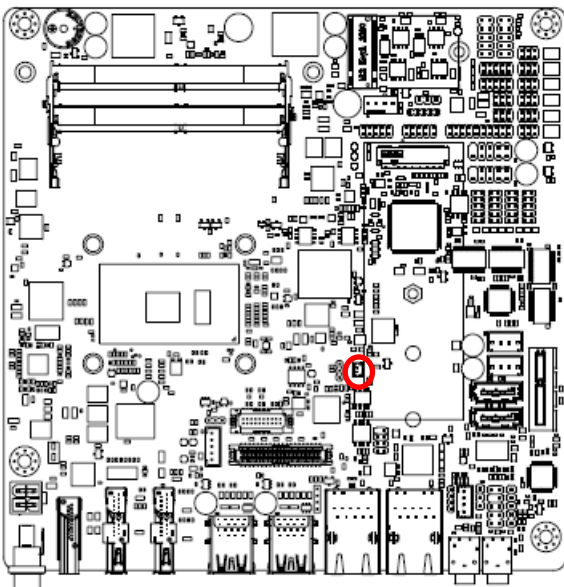

Signal	PIN
+3V	1
GND	2

2.3.15 LVDS connector (LVDS1)

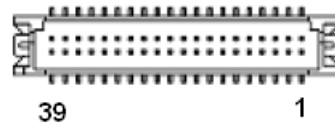
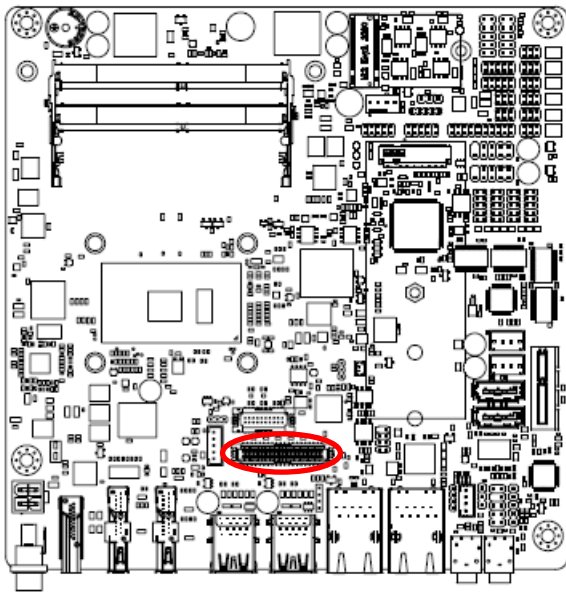

Signal	PIN	PIN	Signal
+5V	2	1	+3.3V
+5V	4	3	+3.3V
NC	6	5	NC
GND	8	7	GND
LVDS_DATA0_P	10	9	LVDS_DATA1_P
LVDS_DATA0_N	12	11	LVDS_DATA1_N
GND	14	13	GND
LVDS_DATA2_P	16	15	LVDS_DATA3_P
LVDS_DATA2_N	18	17	LVDS_DATA3_N
GND	20	19	GND
LVDS_DATA4_P	22	21	LVDS_DATA5_P
LVDS_DATA4_N	24	23	LVDS_DATA5_N
GND	26	25	GND
LVDS_DATA6_P	28	27	LVDS_DATA7_P
LVDS_DATA6_N	30	29	LVDS_DATA7_N
GND	32	31	GND
LVDS_CLK1_P	34	33	LVDS_CLK2_P
LVDS_CLK1_N	36	35	LVDS_CLK2_N
GND	38	37	GND
+12V	40	39	+12V

2.3.16 Audio connector (FAUD1)

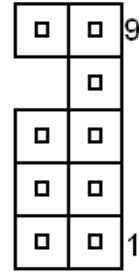
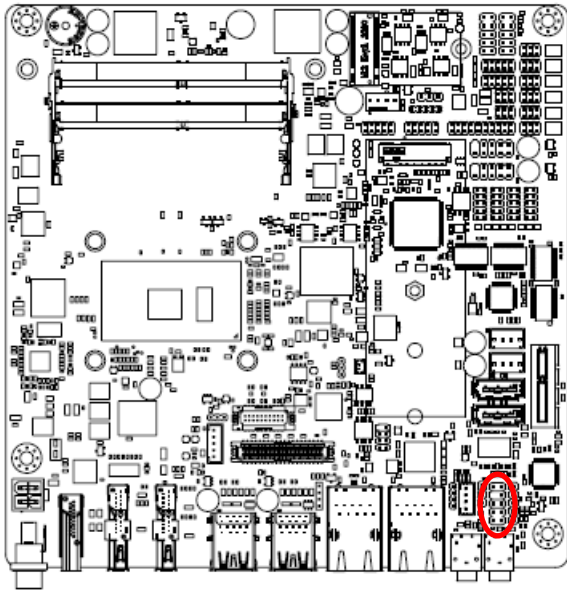

Signal	PIN	PIN	Signal
LINE2_JD	10	9	LINE2_LIN
		7	SENSE_B
MIC2_JD	6	5	LINE2_RIN
AUD_FRONT_DET	4	3	MIC2_RIN
GND	2	1	MIC2_LIN

2.3.17 EC Debug (JEC_SPI)

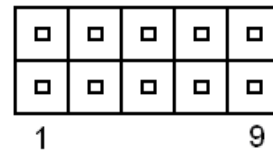
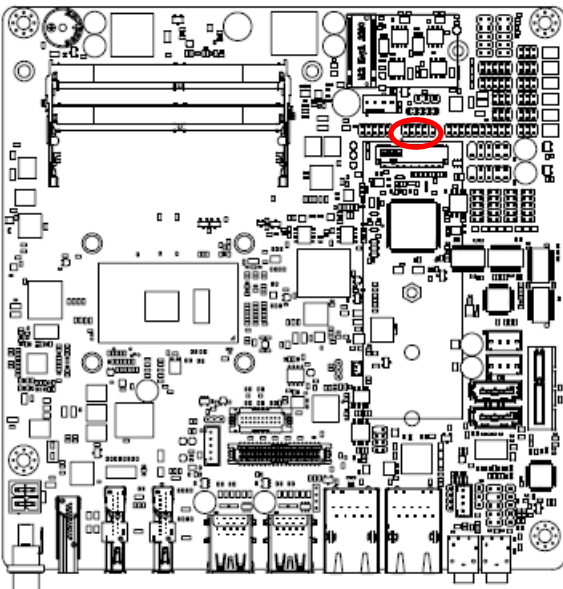

Signal	PIN	PIN	Signal
+3VSPI_EC	1	2	GND
EC_FSCE#	3	4	EC_FSCK
EC_FMISO	5	6	EC_FMOSI
EC_HOLD#	7	8	NC
EC_SMCLK	9	10	EC_SMDAT

2.3.18 SPI connector (JSPI1)

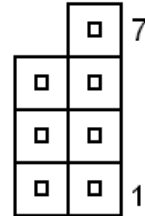
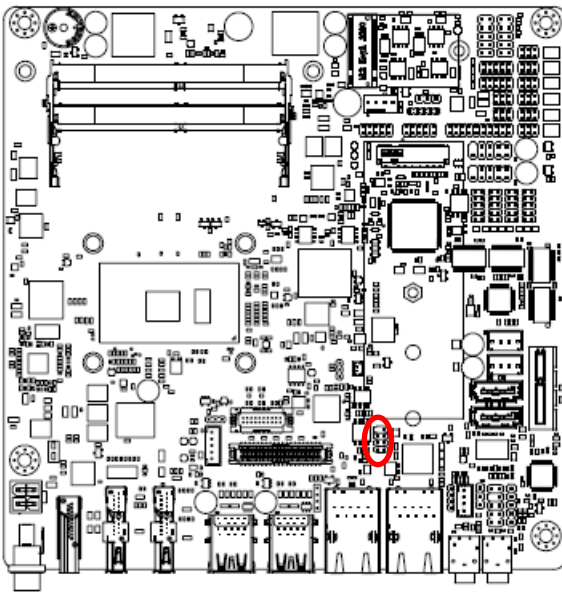

Signal	PIN	PIN	Signal
		7	HOLD#
SPI_SI	6	5	SPI_SO
SPI_CLK	4	3	SPI0_CS0#
GND	2	1	+3.3A_SPI

2.3.19 Sony/Philips Digital Interface (SPDIF1)

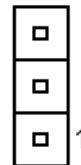
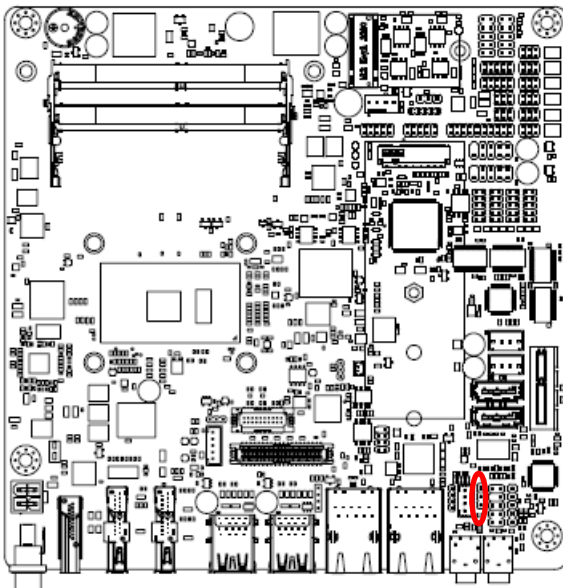

Signal	PIN
GND	3
SPDIF_OUT	2
+5V	1

2.3.20 Miscellaneous setting connector 1 (FPT1)

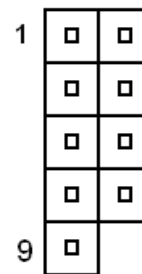
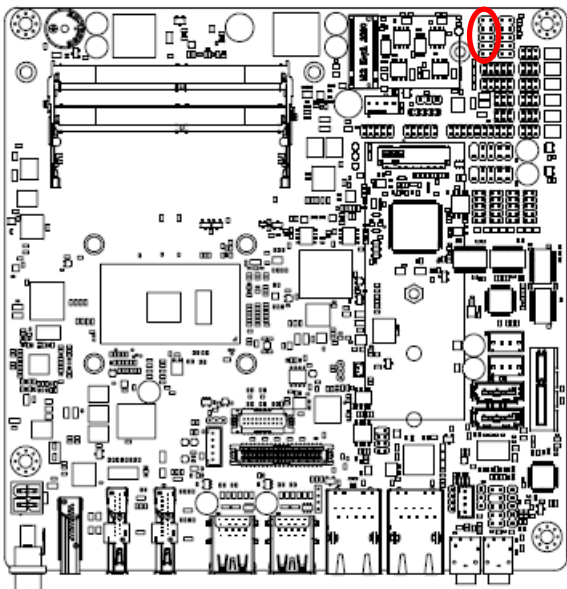

Signal	PIN	PIN	Signal
HD_LED+	1	2	PWR_LED+
HD_LED-	3	4	PWE_LED-
Reset+	5	6	PWR_BNT+
Reset-	7	8	PWR_BNT-
NC	9		

2.3.21 Miscellaneous setting connector 2 (FPT2)

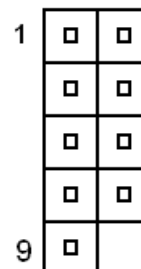
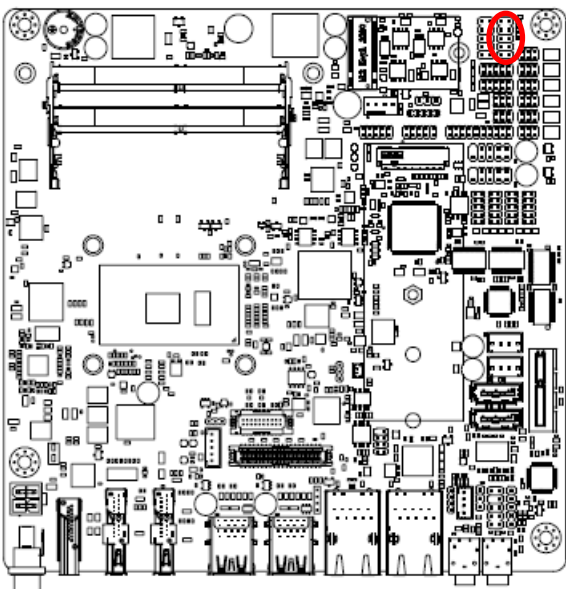

Signal	PIN	PIN	Signal
Speaker+	1	2	BLK_VR(10K)
NC	3	4	BLK_UP
NC	5	6	BLK_DN
Speaker-	7	8	GND
NC	9	10	

Note:

1. Pin2 with GND: Control LVDS Backlight by use Variable Resistor.
2. BLK_UP with GND/BLK_DN with GND: Step control LVDS Backlight by use button and BIOS must to be set "BR Button". (Please refer to page.61)

2.3.22 LED indicator connector 1 (LED1)

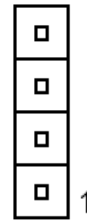
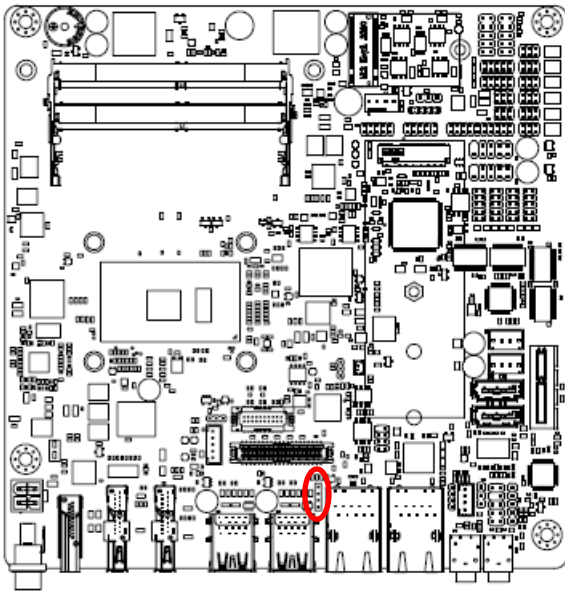

Signal	PIN
LAN1_1000#_LED	4
LAN1_100#_LED	3
LAN1_ACT_N	2
LAN1_ACT_P	1

2.3.23 LED indicator connector 2 (LED2)

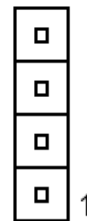
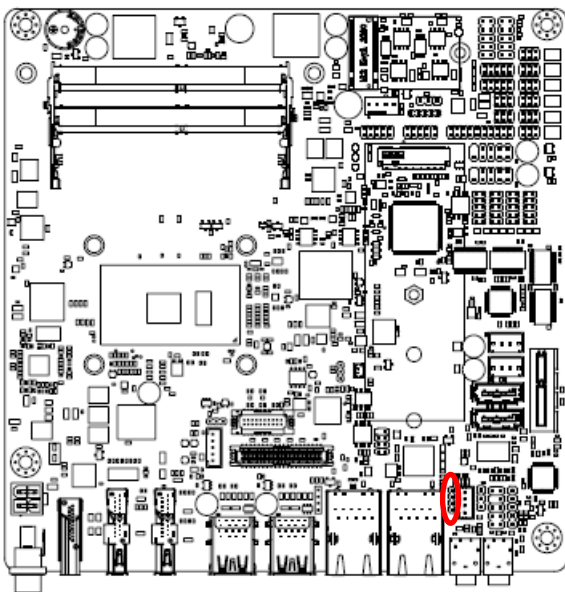

Signal	PIN
LAN2_1000#_LED	4
LAN2_100#_LED	3
LAN2_ACT_N	2
LAN2_ACT_P	1

2.3.24 Speaker connector (SPK1)

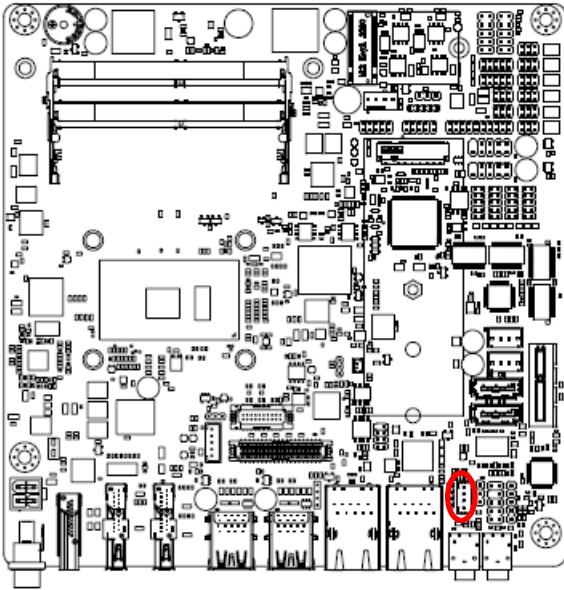

Signal	PIN
SPK_R-	4
SPK_R+	3
SPK_L-	2
SPK_L+	1

2.3.25 Mic-in connector (DMIC1)

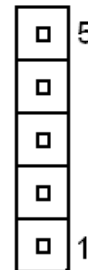
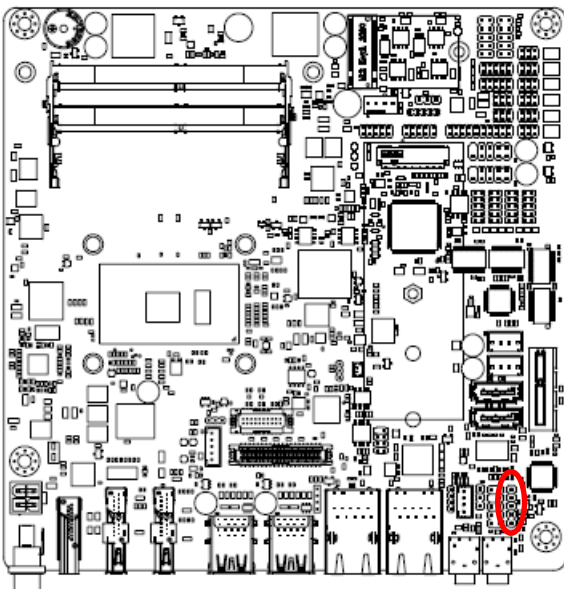

Signal	PIN
NC	5
DMIC_CLK	4
GND	3
DMIC_DATA	2
+3.3V	1

2.3.26 I2C connector (I2C1)

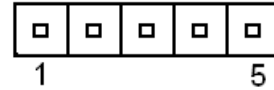
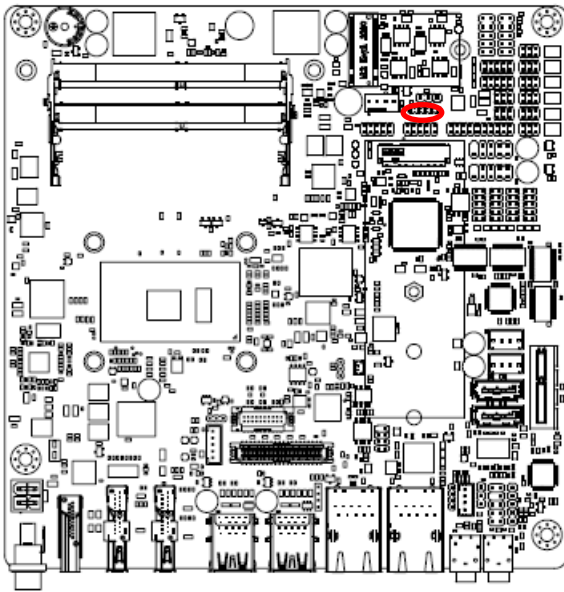

Signal	PIN
+3.3V	1
INT_I2C0#	2
I2C0_CLK	3
I2C0_DATA	4
GND	5

2.3.27 eDP_Panel connector (EDP1)

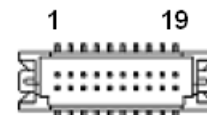
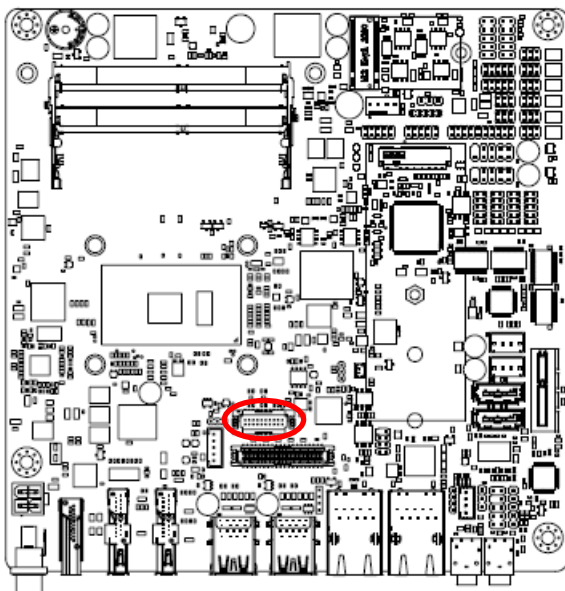

Signal	PIN	PIN	Signal
GND	1	2	GND
EDP_PanelTXN0	3	4	EDP_PanelTXN3
EDP_PanelTXP0	5	6	EDP_PanelTXP3
GND	7	8	NC
EDP_PanelTXN1	9	10	GND
EDP_PanelTXP1	11	12	EDP_PanelAUXN
GND	13	14	EDP_PanelAUXP
EDP_PanelTXN2	15	16	GND
EDP_PanelTXP2	17	18	EDP_Panel_HPDP
+V3512_EDP	19	20	+V3512_EDP

Note:

Default 3.3V.

This a BOM optional part.

2.3.28 LPC connector (JLPC)

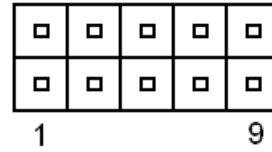
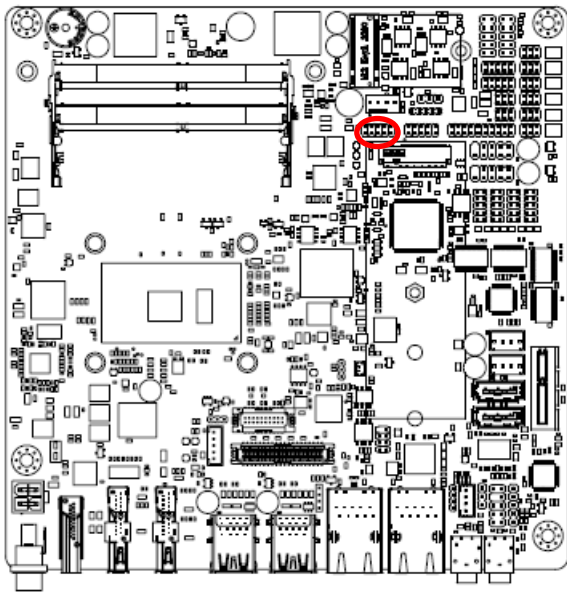

Signal	PIN	PIN	Signal
LPC_AD0	1	2	+3.3V
LPC_AD1	3	4	PCH_PLTRST#
LPC_AD2	5	6	LPC_FRAME#
LPC_AD3	7	8	LPC_CLK
LPC_SERIRQ	9	10	GND

2.3.29 CPU fan connector (FAN1)

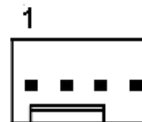
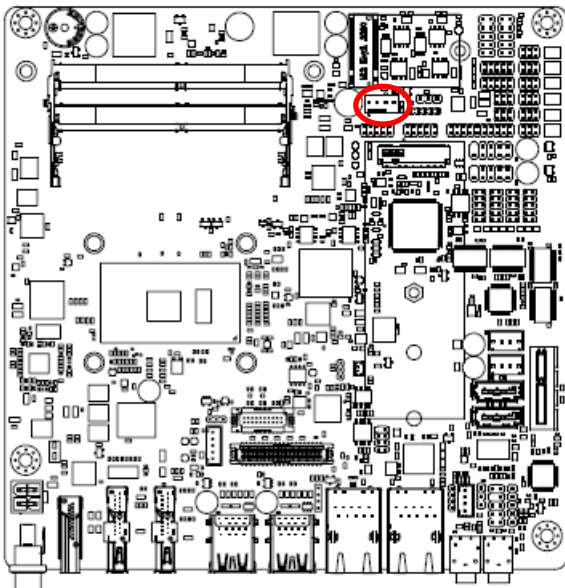

Signal	PIN
GND	1
+12V	2
CPU_FANIN	3
FAN_PWM0	4

2.3.30 HDMI1/DP1/DP2/LVDS1

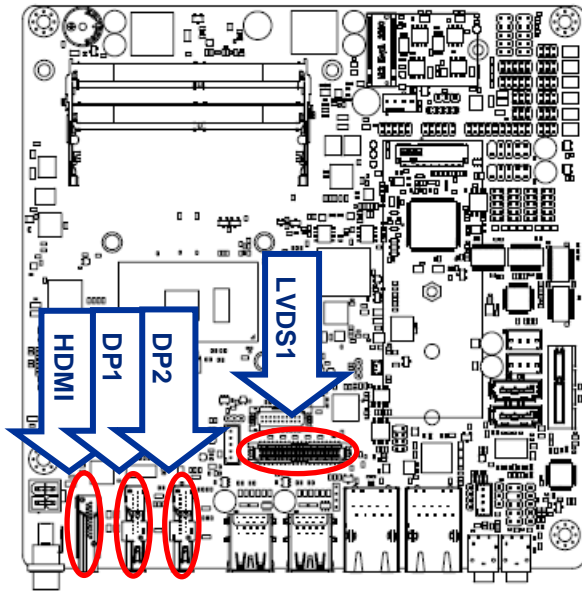

Display	Location
HDMI	HDMI1
DP	DP1
DP++	DP2
LVDS	LVDS1

Display: 1 x DP++(DP2 connector), 1 x HDMI(HDMI1 connector), 1 x DP (DP1 connector), LVDS(LVDS1 connector)

Note: HDMI1 and DP1 share one circuit for display output depending on which monitor input is engaged. (Only one display port can be output, HDMI1 or DP1)

Triple display:

HDMI & DP++ & LVDS

DP & DP++ & LVDS

3. BIOS Setup



3.1 Introduction

The BIOS setup program allows users to modify the basic system configuration. In this following chapter will describe how to access the BIOS setup program and the configuration options that may be changed.

3.2 Starting Setup

The AMI BIOS™ is immediately activated when you first power on the computer. The BIOS reads the system information contained in the NVRAM and begins the process of checking out the system and configuring it. When it finishes, the BIOS will seek an operating system on one of the disks and then launch and turn control over to the operating system.

While the BIOS is in control, the Setup program can be activated in one of two ways:

By pressing or <F2> immediately after switching the system on, or

By pressing the or <F2> key when the following message appears briefly at the left-top of the screen during the POST (Power On Self Test).

Press or <F2> to enter SETUP

If the message disappears before you respond and you still wish to enter Setup, restart the system to try again by turning it OFF then ON or pressing the "RESET" button on the system case. You may also restart by simultaneously pressing <Ctrl>, <Alt>, and <Delete> keys. If you do not press the keys at the correct time and the system does not boot, an error message will be displayed and you will again be asked to.

Press F1 to Continue, DEL to enter SETUP

3.3 Using Setup

In general, you use the arrow keys to highlight items, press <Enter> to select, use the PageUp and PageDown keys to change entries, press <F1> for help and press <Esc> to quit. The following table provides more detail about how to navigate in the Setup program using the keyboard.

Button	Description
↑↓→←	Move
Enter	Select
+/-	Value
Esc	Exit
F1	General Help
F2	Previous Values
F3	Optimized Defaults
F4	Save & Exit Setup
<K>	Scroll help area upwards
<M>	Scroll help area downwards

- **Navigating Through The Menu Bar**

Use the left and right arrow keys to choose the menu you want to be in.



Note: Some of the navigation keys differ from one screen to another.

- **To Display a Sub Menu**

Use the arrow keys to move the cursor to the sub menu you want. Then press <Enter>. A “>” pointer marks all sub menus.

3.4 Getting Help

Press F1 to pop up a small help window that describes the appropriate keys to use and the possible selections for the highlighted item. To exit the Help Window press <Esc> or <Enter> key.

3.5 In Case of Problems

If, after making and saving system changes with Setup, you discover that your computer no longer is able to boot, the AMI BIOS supports an override to the NVRAM settings which resets your system to its defaults.

The best advice is to only alter settings which you thoroughly understand. To this end, we strongly recommend that you avoid making any changes to the chipset defaults. These defaults have been carefully chosen by both BIOS Vendor and your systems manufacturer to provide the absolute maximum performance and reliability. Even a seemingly small change to the chipset setup has the potential for causing you to use the override.

3.6 BIOS setup

Once you enter the Aptio Setup Utility, the Main Menu will appear on the screen. The Main Menu allows you to select from several setup functions and exit choices. Use the arrow keys to select among the items and press <Enter> to accept and enter the sub-menu.

3.6.1 Main Menu

This section allows you to record some basic hardware configurations in your computer and set the system clock.

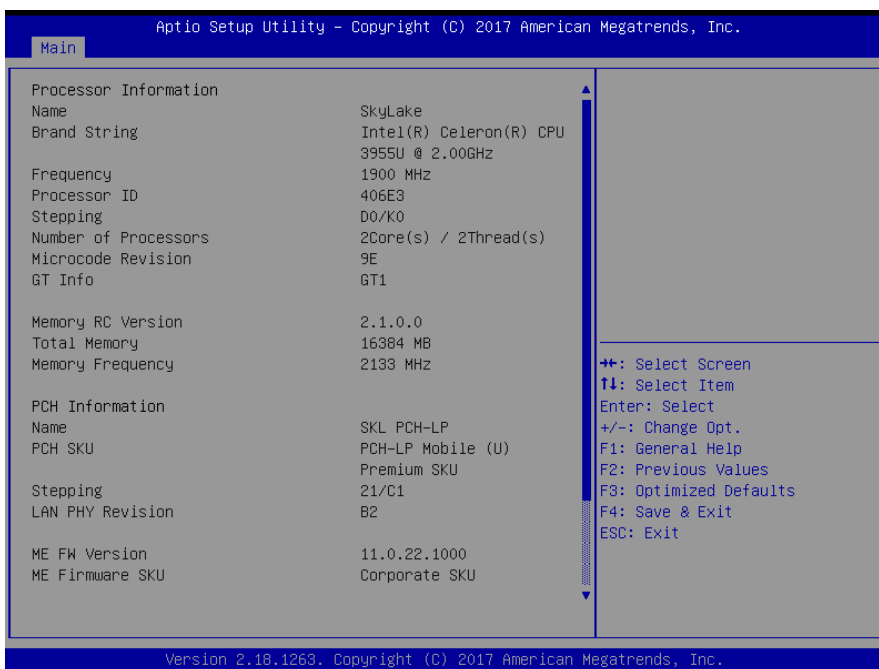

3.6.1.1 System Language

This option allows choosing the system default language.

3.6.1.2 System Date

Use the system date option to set the system date. Manually enter the day, month and year.

3.6.1.3 System Time

Use the system time option to set the system time. Manually enter the hours, minutes and seconds.



Note: The BIOS setup screens shown in this chapter are for reference purposes only, and may not exactly match what you see on your screen.

Visit the Avalue website (www.avalu.com.tw) to download the latest product and BIOS information.

3.6.2 Advanced Menu

This section allows you to configure your CPU and other system devices for basic operation through the following sub-menus.

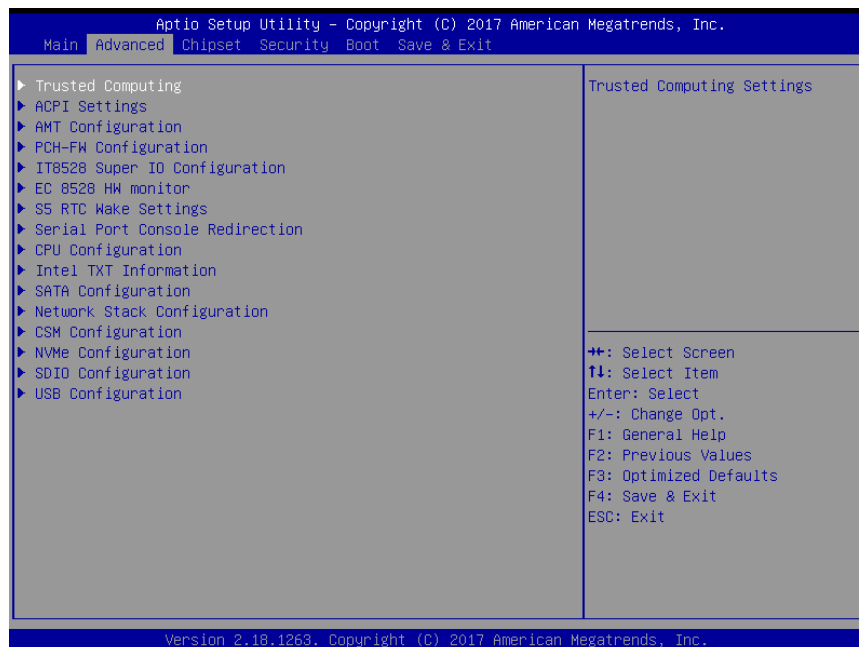

EMX-SKLUP User's Manual

3.6.2.1 Trusted Computing

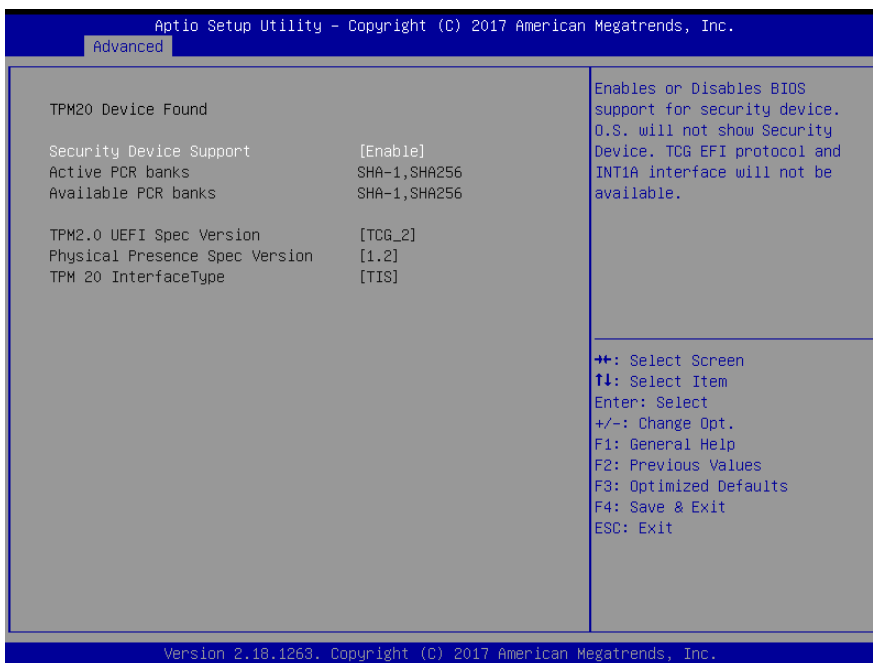

Item	Options	Description
Security Device Support	Disable Enable [Default]	Enables or Disables BIOS support for security devices. O.S. will not show Security Device. TCG EFI protocol and INT1A interface will not be available.

3.6.2.2 ACPI Settings

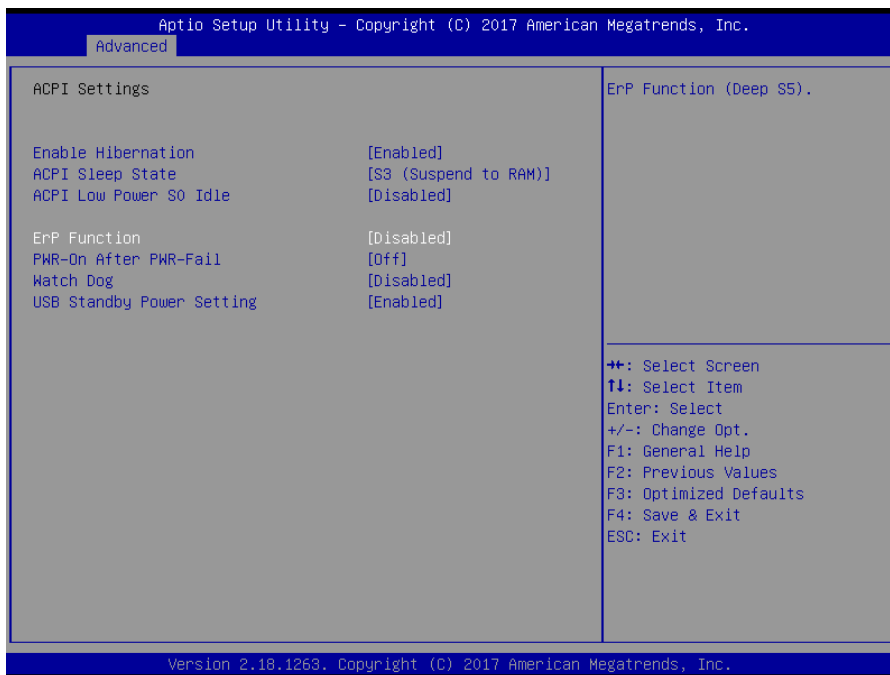

Item	Options	Description
Enable Hibernation	Disabled Enabled[Default],	Enables or Disables System ability to Hibernate (OS/S4 Sleep State). This option may be not effective with some OS.
ACPI Sleep State	Suspend Disabled, S3 (Suspend to RAM)[Default]	Select the highest ACPI sleep state the system will enter when the SUSPEDN button is pressed.
ACPI Low Power S0 Idle	Disabled[Default] Enabled,	Enable or Disable ACPI Low Power S0 Idle Support.
ErP Function	Disabled[Default] Enabled,	ErP Function (Deep S5).
PWR-On After PWR-Fail	Off[Default] On Last state	AC loss resume.
Watch Dog	Disabled[Default], 30 sec 40 sec 50 sec 1 min 2 min 10 min 30 min	Select WatchDog.
USB Standby Power Setting	Disabled Enabled[Default]	Enabled/Disabled USB Standby Power during S3/S4/S5.

3.6.2.3 AMT Configuration

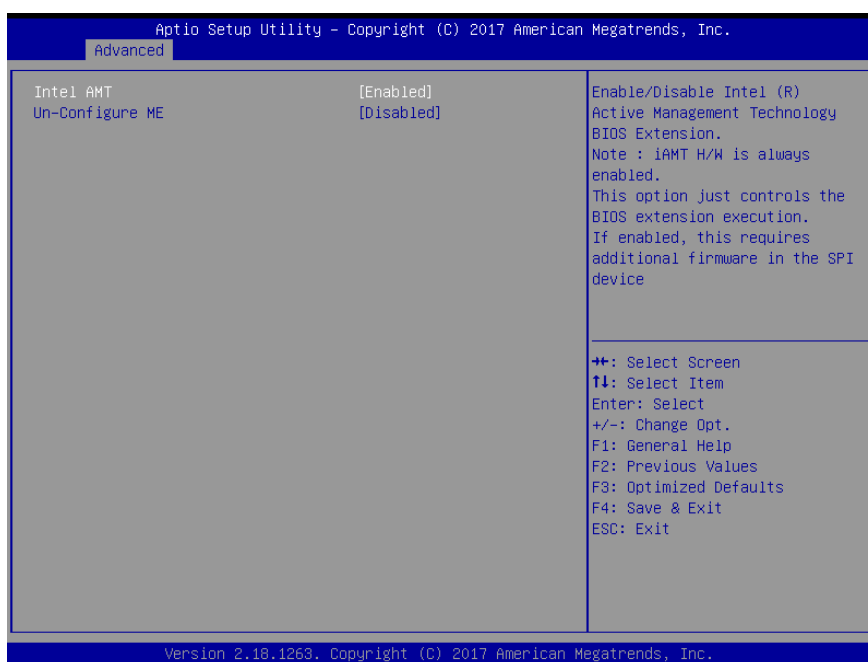

EMX-SKLUP User's Manual

Item	Options	Description
Intel AMT	Disabled Enabled[Default],	Enable/Disable Intel® Active Management Technology BIOS Extension. Note: iAMT H/W is always enabled. This option just controls the BIOS extension execution. If enabled, this requires additional firmware in the SPI device.
Un-Configure ME	Disabled[Default] Enabled,	OEMFlag Bit 15: Un-Configure ME without password.

3.6.2.4 PCH-FW Configuration

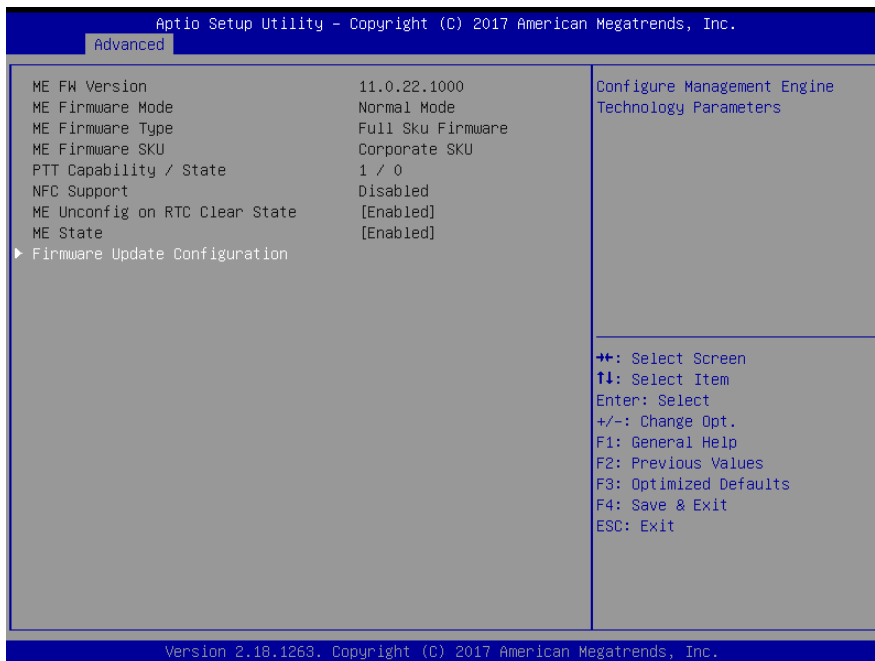

3.6.2.4.1 Firmware Update Configuration

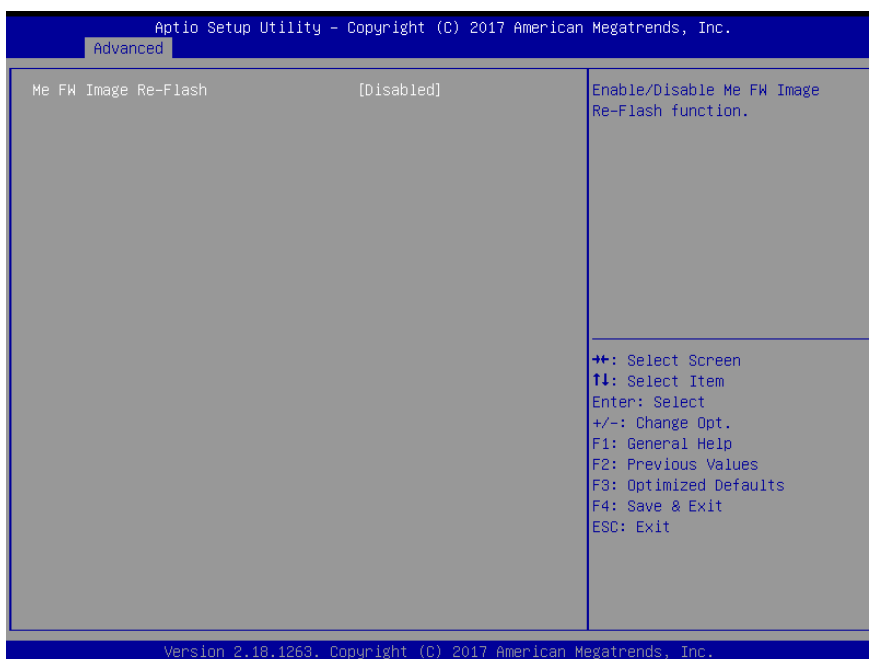

Item	Options	Description
Me FW Image Re-Flash	Disabled[Default], Enabled	Enable/Disable Me FW Image Re-Flash function.

3.6.2.5 IT8528 Super IO Configuration

You can use this item to set up or change the IT8528 Super IO configuration for serial ports. Please refer to 3.6.2.5.1~ 3.6.2.5.6 for more information.

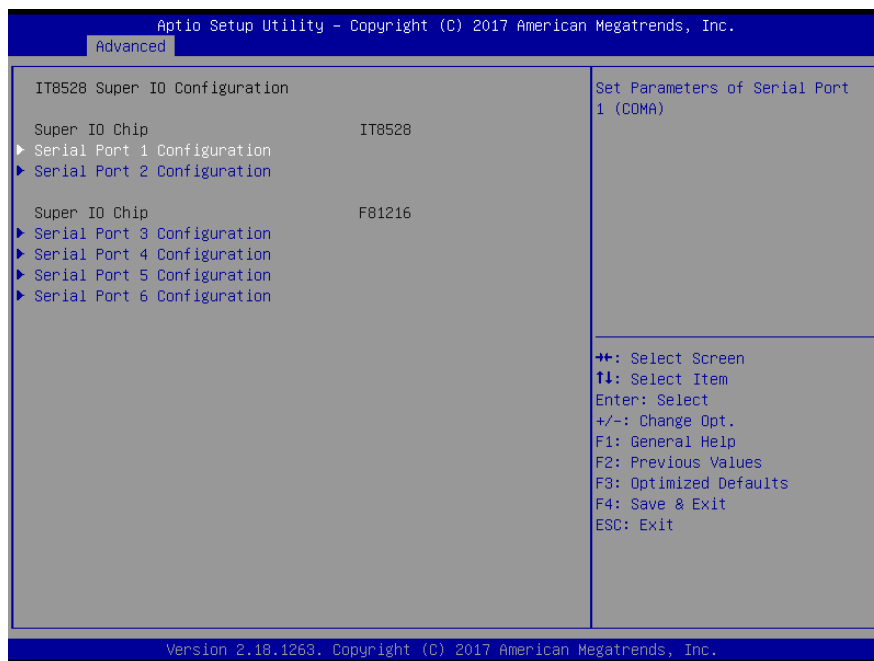

Item	Description
Serial Port 1 Configuration	Set Parameters of Serial Port 1 (COMA).
Serial Port 2 Configuration	Set Parameters of Serial Port 2 (COMB).
Serial Port 3 Configuration	Set Parameters of Serial Port 3 (COMC).
Serial Port 4 Configuration	Set Parameters of Serial Port 4 (COMD).
Serial Port 5 Configuration	Set Parameters of Serial Port 5 (COME).
Serial Port 6 Configuration	Set Parameters of Serial Port 6 (COMF).

EMX-SKLUP User's Manual

3.6.2.5.1 Serial Port 1 Configuration

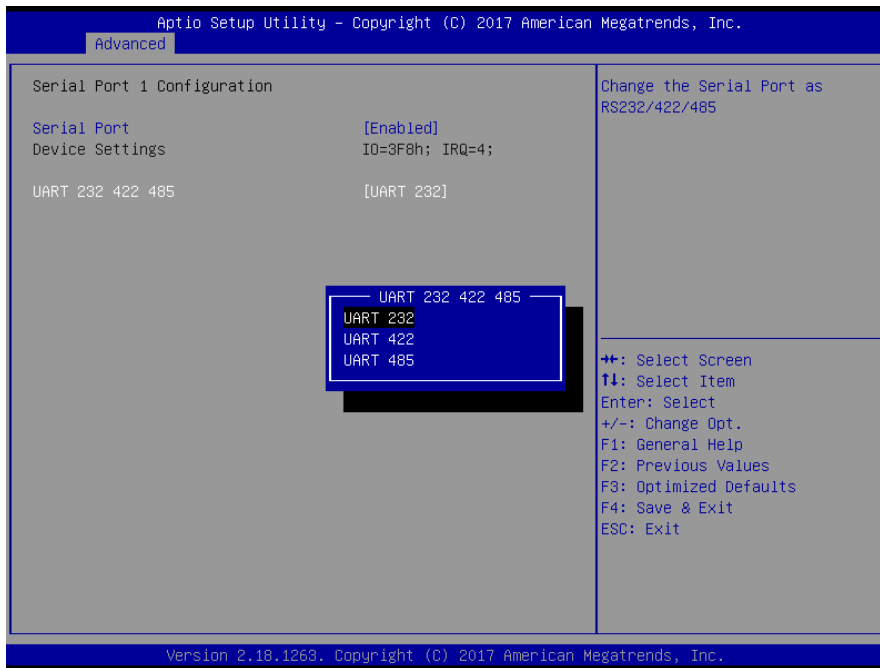

Item	Option	Description
Serial Port	Enabled[Default], Disabled	Enable or Disable Serial Port (COM).
UART 232 422 485	UART 232[Default], UART 422, UART 485	Change the Serial Port as RS232/422/485.

3.6.2.5.2 Serial Port 2 Configuration



Item	Option	Description
Serial Port	Enabled[Default], Disabled	Enable or Disable Serial Port (COM).
UART 232 422 485	UART 232[Default], UART 422, UART 485	Change the Serial Port as RS232/422/485.

3.6.2.5.3 Serial Port 3 Configuration



Item	Option	Description
Serial Port	Enabled[Default], Disabled	Enable or Disable Serial Port (COM).

3.6.2.5.4 Serial Port 4 Configuration

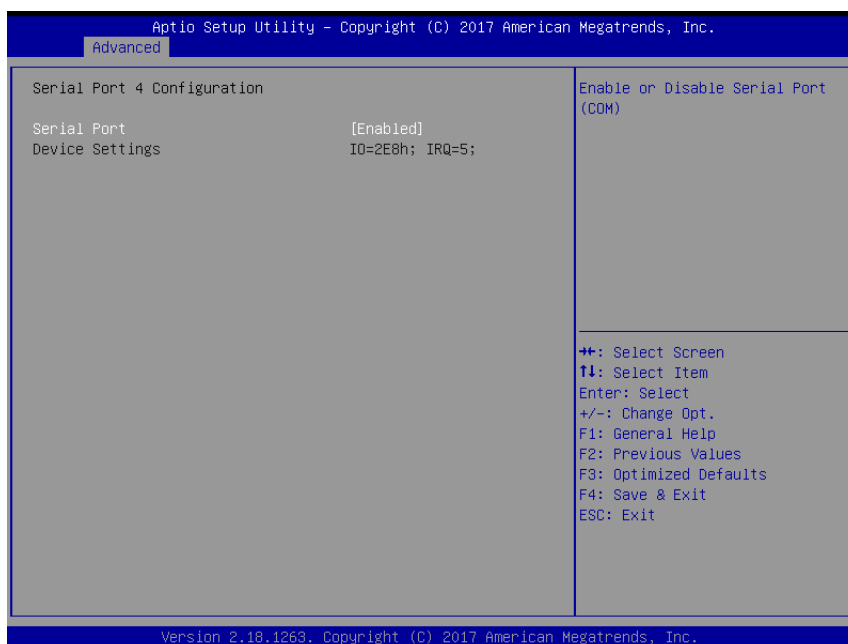

Item	Option	Description
Serial Port	Enabled[Default], Disabled	Enable or Disable Serial Port (COM).

3.6.2.5.5 Serial Port 5 Configuration

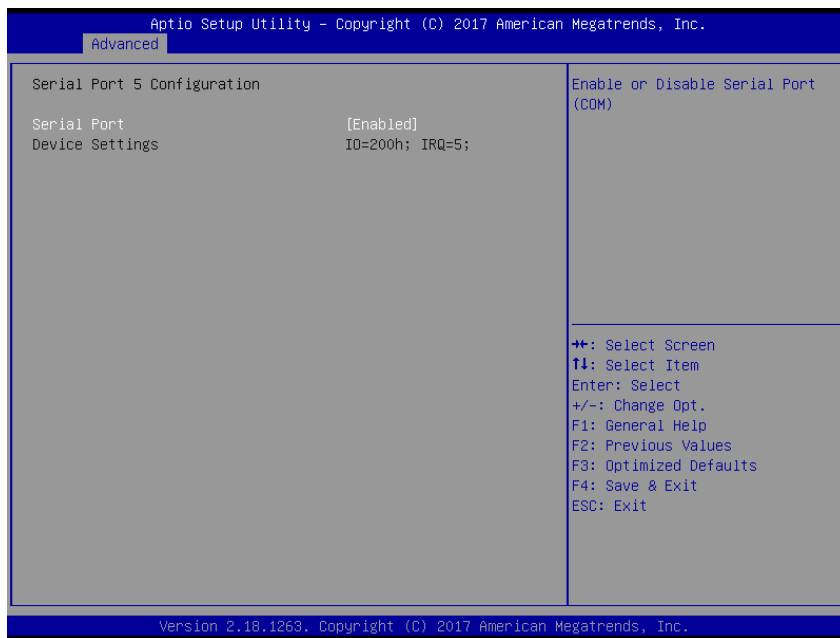

Item	Option	Description
Serial Port	Enabled[Default], Disabled	Enable or Disable Serial Port (COM).

3.6.2.5.6 Serial Port 6 Configuration

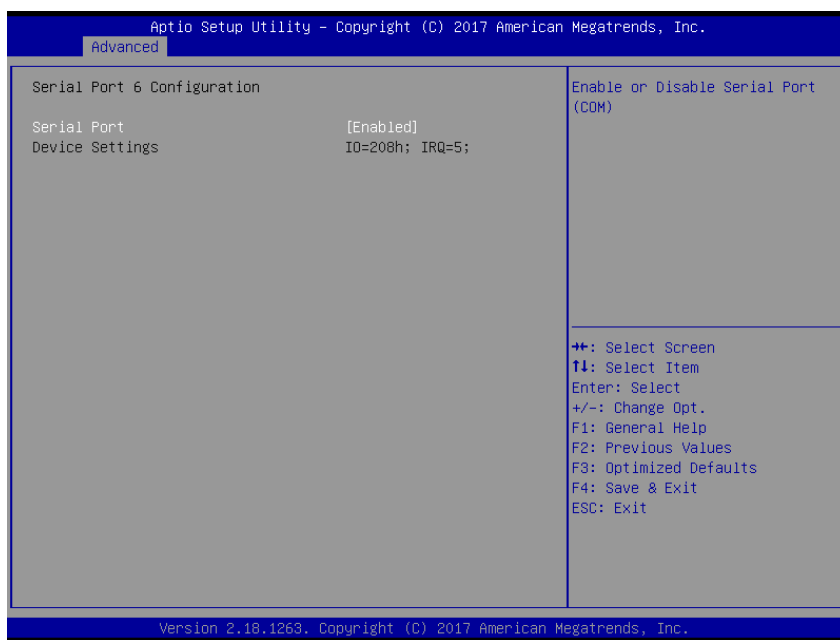

Item	Option	Description
Serial Port	Enabled[Default], Disabled	Enable or Disable Serial Port (COM).

3.6.2.6 H/W Monitor

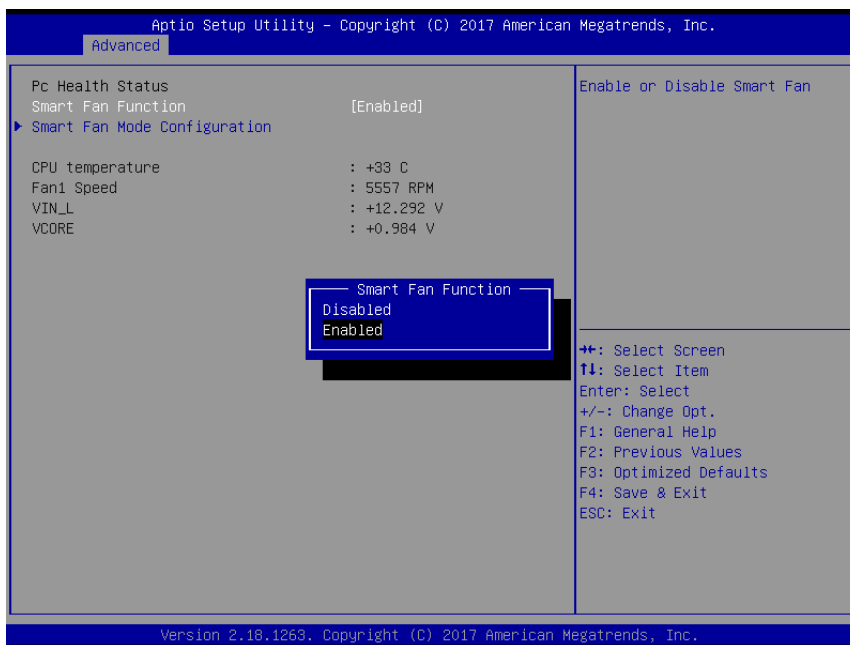

Item	Options	Description
Smart Fan Function	Disabled[Default], Enabled	Enable or Disable Smart Fan.

3.6.2.6.1 Smart Fan Mode Configuration

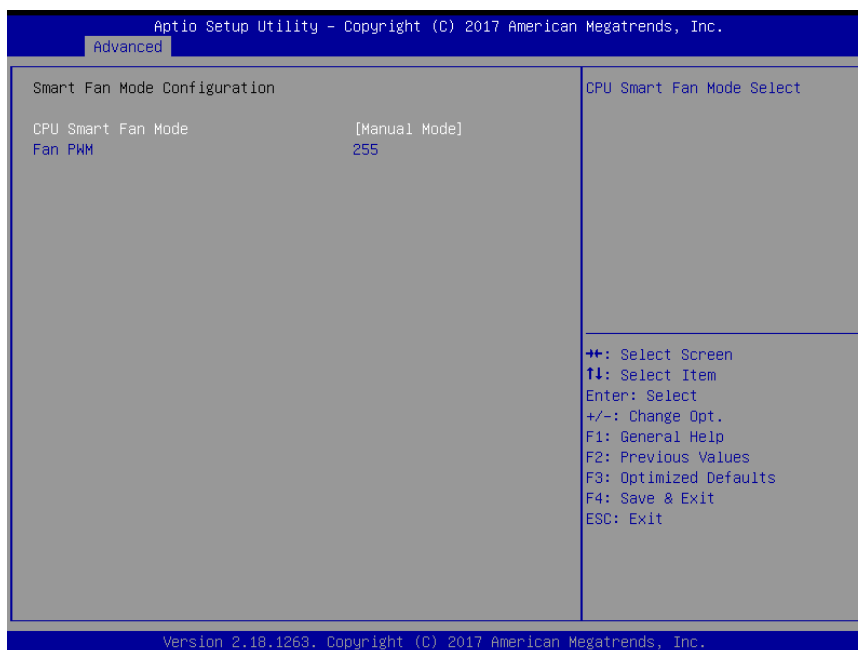

EMX-SKLUP User's Manual

Item	Option	Description
CPU Smart Fan Mode	Manual Mode[Default]/Mode 01/Mode 02/Mode 03/Mode 04/Mode 05/Mode 06/Mode 07/Mode 08/Mode 09/Mode 10/Mode 11/Mode 12/Mode 13/Mode 14/Mode 15/Mode 16/Mode 17/Mode 18/Mode 19/Mode 20	CPU Smart Fan Mode Select.
Fan PWM	0-255	Fan PWM duty

3.6.2.7 S5 RTC Wake Settings

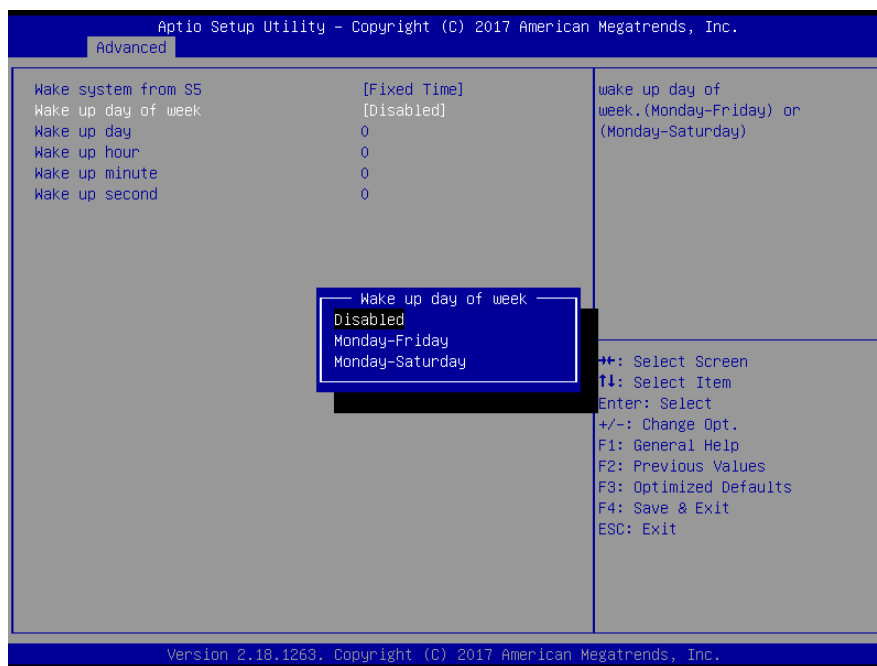

Item	Options	Description
Wake system from S5	Disabled[Default], Fixed Time Dynamic Time	Enable or disable System wake on alarm event. Select FixedTime, system will wake on the hr::min::sec specified. Select DynamicTime, System will wake on the current time + Increase minutes(s).
Wake up day of week	Disabled[Default], Monday-Friday Monday-Saturday	Wake up day of week. (Monday-Friday) or (Monday-Saturday).
Wake up day	1-31	Select 0 for daily system wake up 1-31 for which day of the month that you would like the system to wake up.
Wake up hour	0-23	Select 0-23 For example enter 3 for 3am and 15 for 3pm.
Wake up minute	0-59	Select 0-23 For example enter 3 for 3am and 15 for 3pm.
Wake up second	0-59	Select 0-23 For example enter 3 for 3am and 15 for 3pm.

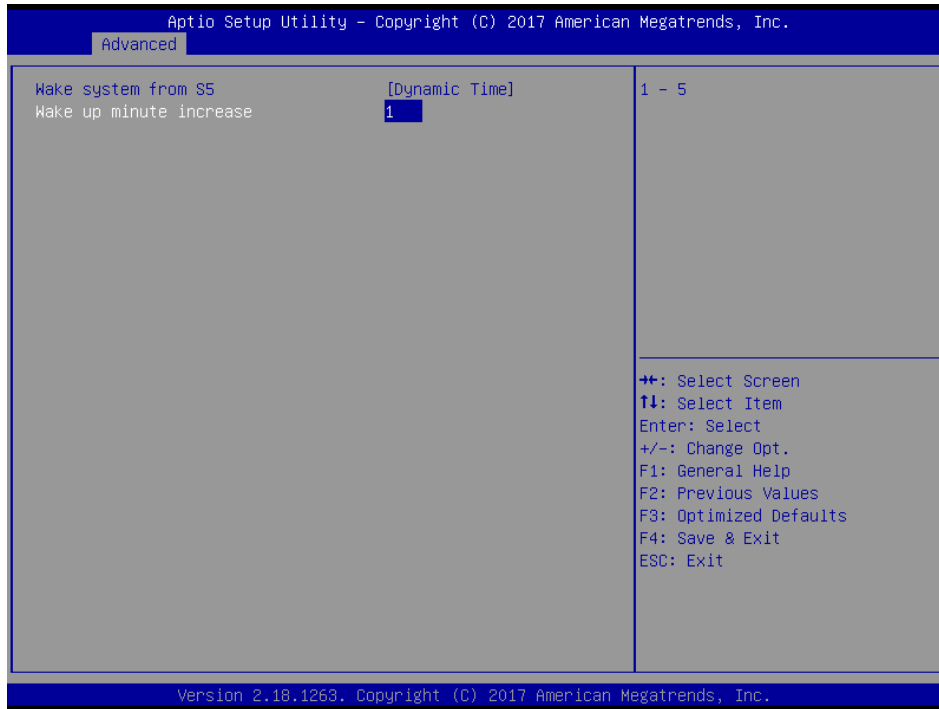

Item	Options	Description
Wake system from S5	Disabled, Fixed Time Dynamic Time[Default]	Enable or disable System wake on alarm event. Select FixedTime, system will wake on the hr::min::sec specified. Select DynamicTime, System will wake on the current time + Increase minutes(s).
Wake up minute increase	1-5	1-5.

3.6.2.8 Serial Port Console Redirection

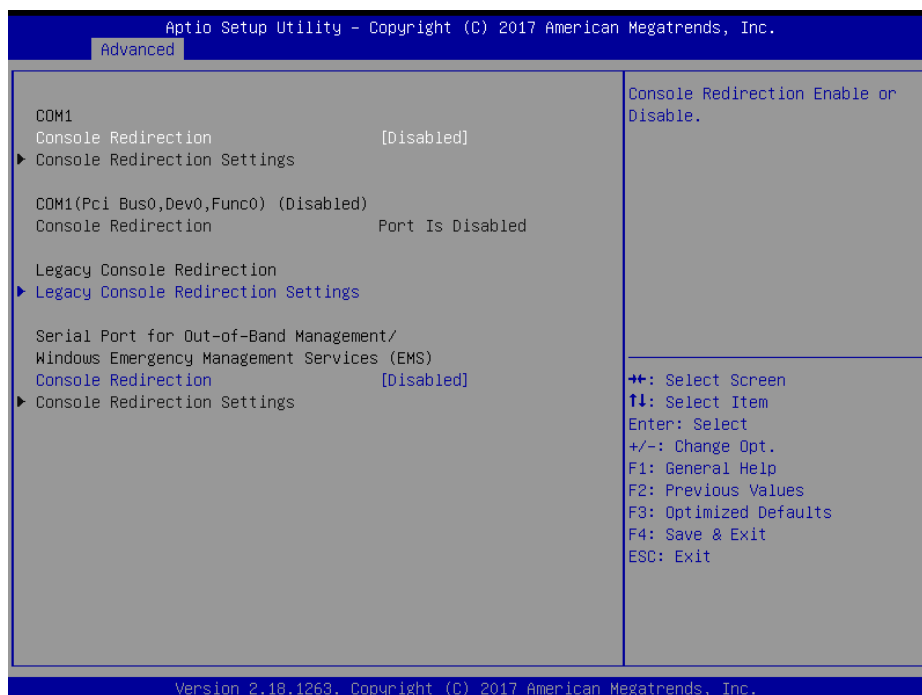

EMX-SKLUP User's Manual

Item	Options	Description
Console Redirection	Disabled[Default], Enabled	Console Redirection Enable or Disable.

3.6.2.8.1 COM1

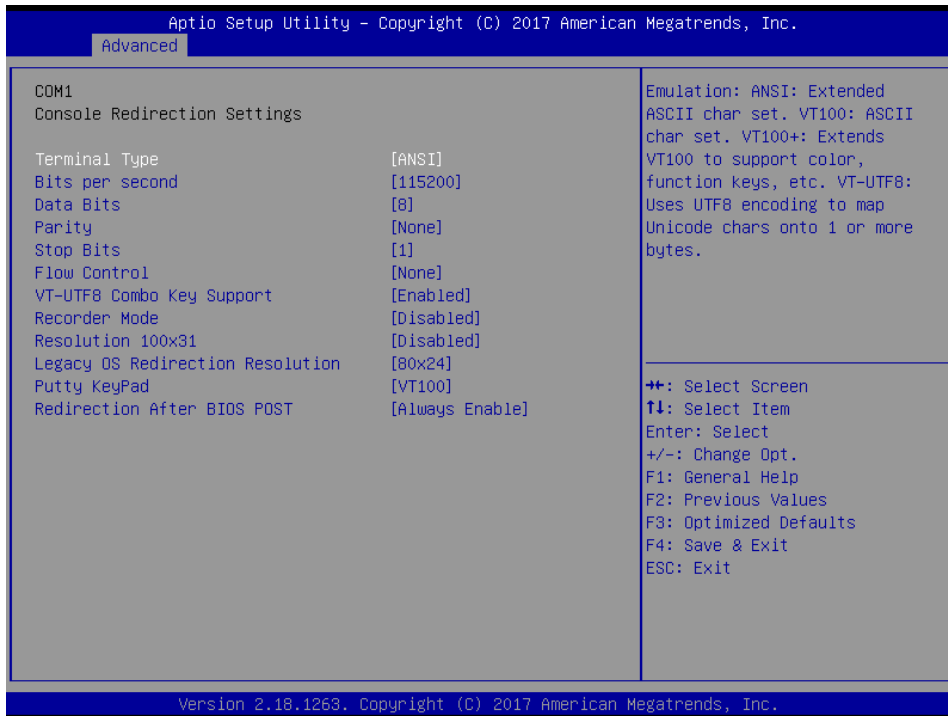

Item	Option	Description
Terminal Type	VT100 VT100+ VT-UTF8 ANSI[Default]	Emulation: ANSI: Extended ASCII char set. VT100: ASCII char set. VT100+: Extends VT100 to support color, function keys, etc. VT-UTF8: Uses UTF8 encoding to map Unicode chars onto 1 or more bytes.
Bits per second	9600 19200 38400 57600 115200[Default]	Select serial port transmission speed. The speed must be matched on the other side. Long or noisy lines may require lower speeds.
Data Bits	7 8[Default]	Data Bits.
Parity	None[Default] Even Odd Mark Space	A parity bit can be sent with the data bits to detect some transmission errors. Even: parity bit is 0 if the num of 1's in the data bits is even. Odd:parity bit is 0 if num of 1's in the data bits is odd. Mark: parity bit is always 1. Space: Parity bit is always 0. Mark and Space Parity do not allow for error detection. They can be used as and additional data bit.
Stop Bits	1[Default] 2	Stop bits indicate the end of a serial data packet. (A start bit indicates the beginning). The standard setting is 1 stop bit. Communication

		with slow devices may require more than 1 stop bit.
Flow Control	None [Default] Hardware RTS/CTS	Flow control can prevent data loss from buffer overflow. When sending data, if the receiving buffers are full, a 'stop' signal can be sent to stop the data flow. Once the buffers are empty, a 'start' signal can be sent to re-start the flow. Hardware flow control uses two wires to send start/stop signals.
VT-UTF8 Combo Key Support	Disabled Enabled [Default]	Enable VT-UTF8 Combination Key Support for ANSI/VT100 terminals.
Recorder Mode	Disabled [Default] Enabled	With this mode enabled only text will be sent. This is to capture Terminal data.
Resolution 100x31	Disabled [Default] Enabled	Enables or disables extended terminal resolution.
Legacy OS Redirection Resolution	80x24 [Default] 80x25	On Legacy OS, the Number of Rows and Columns supported redirection.
Putty KeyPad	VT100 [Default] LINUX XTERMR6 SCO ESCN VT400	Select FunctionKey and KeyPad on Putty.
Redirection After BIOS POST	Always Enable [Default] Boot Loader	When Bootloader is selected, then Legacy Console Redirection is disabled before booting to legacy OS. When Always Enabled is selected, then Legacy Console Redirection is enabled for legacy OS. Default setting for this option is set to Always Enable.

3.6.2.9 CPU Configuration

Use the CPU configuration menu to view detailed CPU specification and configure the CPU.

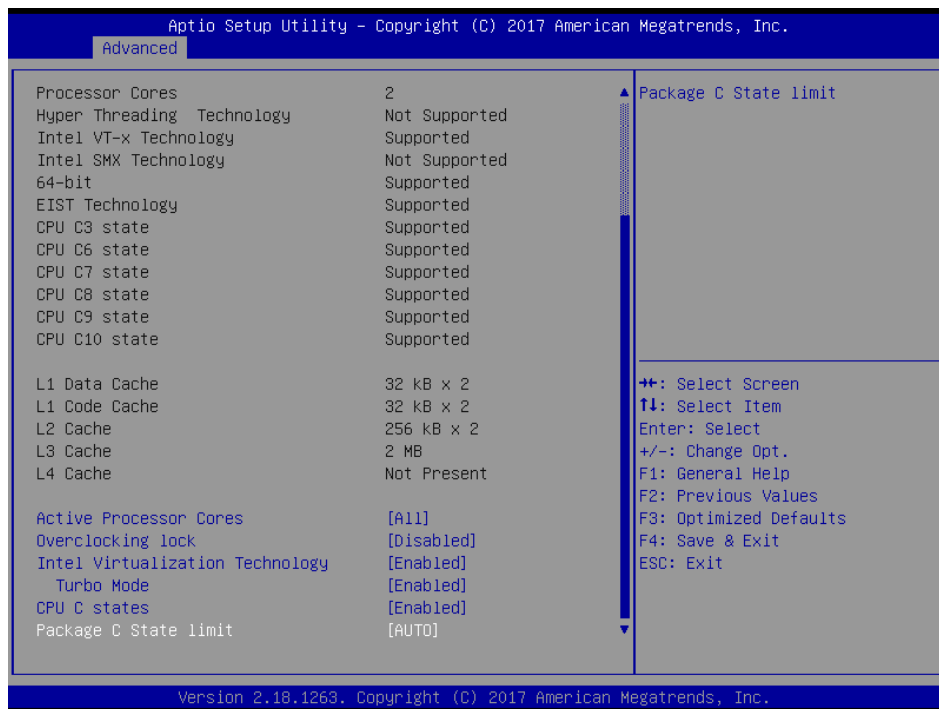
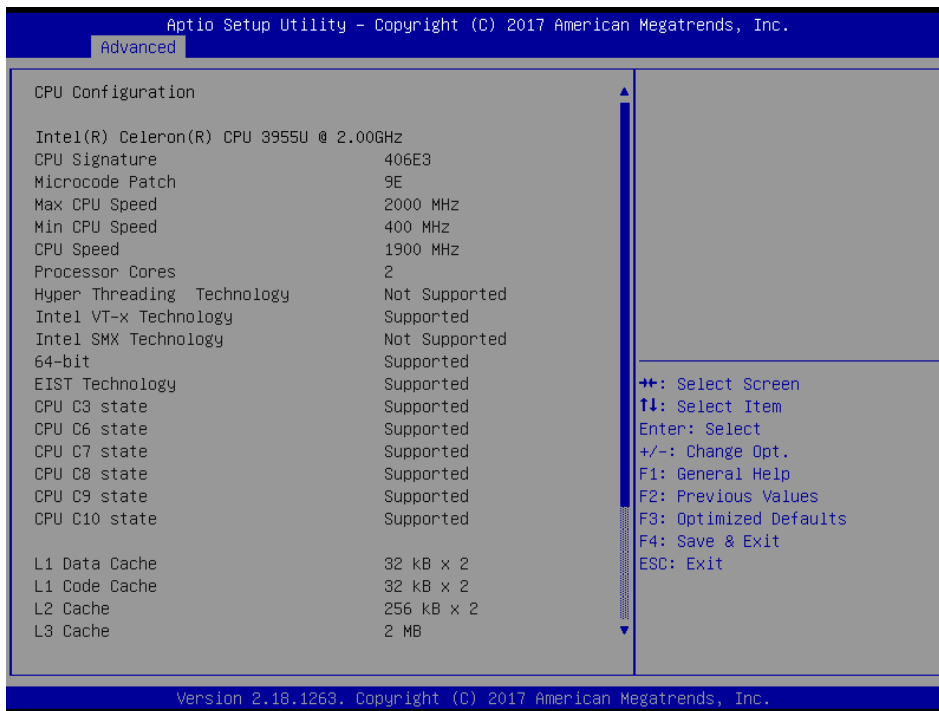

Item	Options	Description
Active Processor Cores	All[Default] 1	Number of cores to enable in each processor package.

Overclocking lock	Disabled[Default], Enabled	FLEX_RATIO(194) MSR.
Intel Virtualization Technology	Disabled, Enabled[Default]	When enabled, a VMM can utilize the additional hardware capabilities provided by Virtualization Technology.
Turbo Mode	Disabled, Enabled[Default]	Turbo Mode.
CPU C states	Disabled, Enabled[Default]	Enable or disable CPU states.
Package C State limit	C0/C1 C2 C3 C6 C7 C7s C8 C9 C10 Auto[Default]	Package C State limit.

3.6.2.10 Intel TXT Information

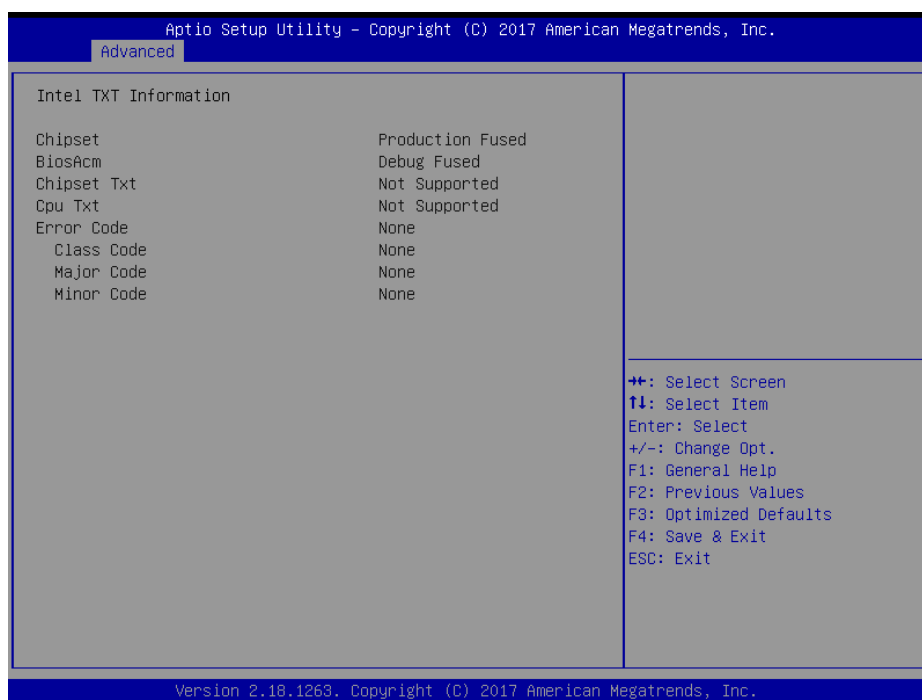

3.6.2.11 SATA Configuration

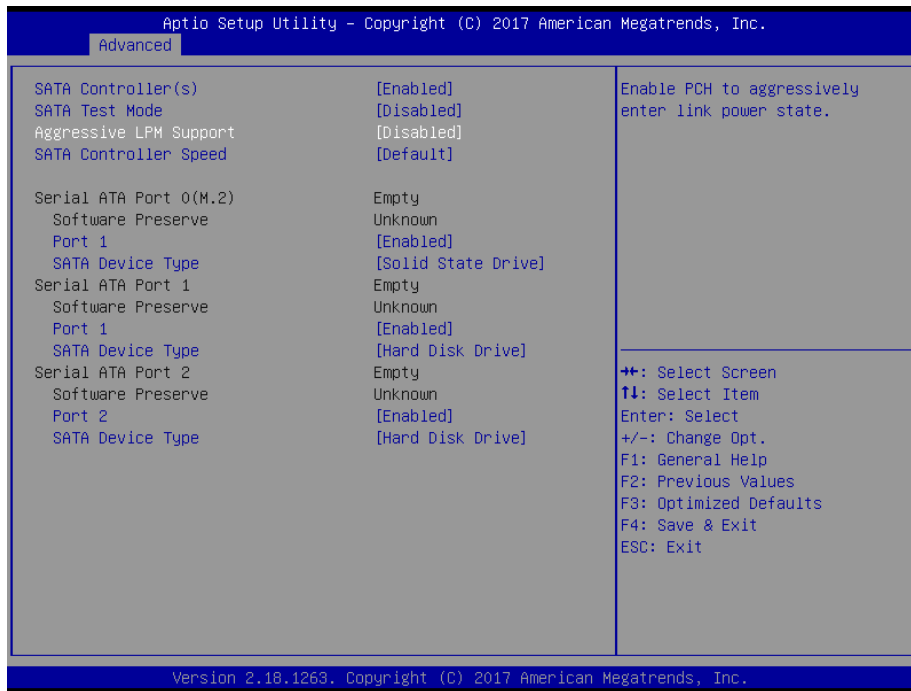

Item	Options	Description
SATA Controller(s)	Disabled, Enabled [Default]	Enable or disable SATA Device.
SATA Test Mode	Disabled [Default] , Enabled	Test Mode Enable/Disable (Loop Back).
Aggressive LPM Support	Disabled [Default] , Enabled	Enable PCH to aggressively enter link power state.
SATA Controller Speed	Default [Default] Gen1 Gen2 Gen3	Indicates the maximum speed the SATA controller can support.
Port1/2	Disabled, Enabled [Default]	Enable/Disable SATA Port.
SATA Device Type	Hard Disk Drive Solid State Drive [Default]	Identify the SATA port is connected to Solid State Drive or Hard Disk Drive.

3.6.2.12 Network Stack Configuration

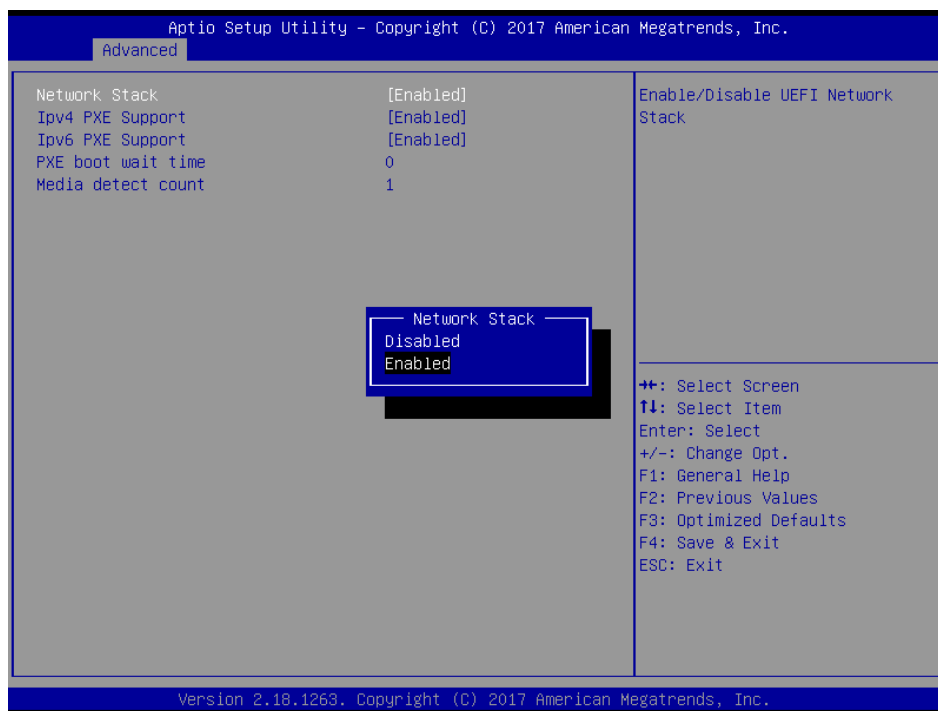

Item	Options	Description
Network Stack	Enabled Disabled[Default]	Enable/Disable UEFI Network Stack.
Ipv4 PXE Support	Disabled Enabled[Default]	Enable Ipv4 PXE Boot Support. If disabled IPV4 PXE boot option will not be created.
Ipv6 PXE Support	Disabled Enabled[Default]	Enable Ipv6 PXE Boot Support. If disabled IPV6 PXE boot option will not be created.
PXE boot wait time	0	Wait time to press ESC key to abort the PXE boot.
Media detect count	1	Number of times presence of media will be checked.

3.6.2.13 CSM Configuration

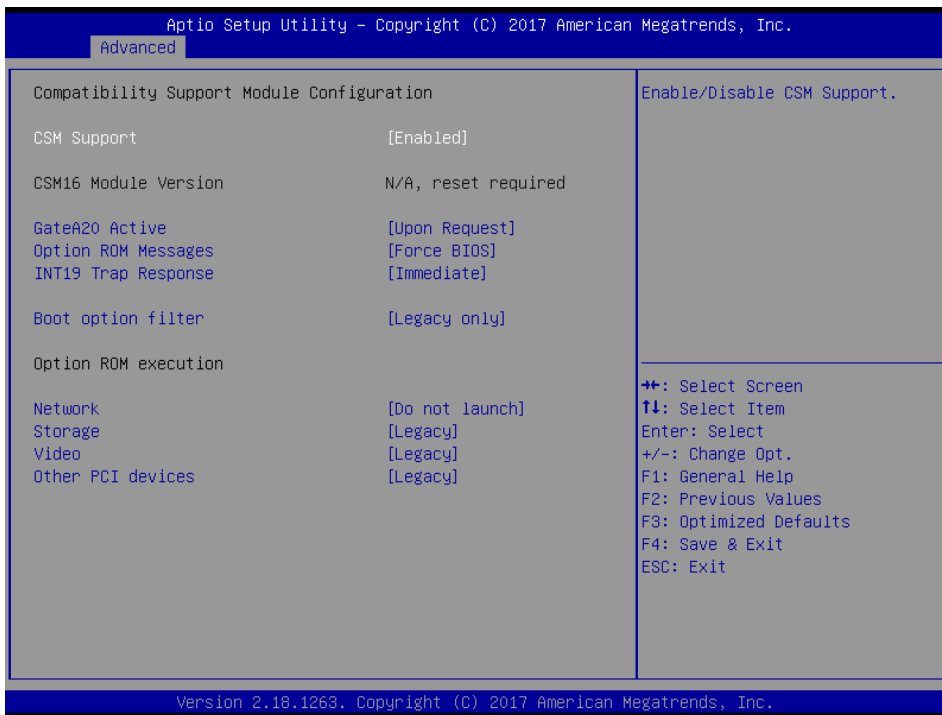

Item	Options	Description
CSM Support	Enabled[Default] Disabled,	Enable/Disable CSM Support.
GateA20 Active	Upon Request[Default] Always	UPON REQUEST – GA20 can be disabled using BIOS services. ALWAYS – do not allow disabling GA20; this option is useful when any RT code is executed above 1MB.
Option ROM Messages	Force BIOS[Default] Keep Current	Set display mode for Option ROM.
INT19 Trap Response	Immediate[Default] Postponed	BIOS reaction on INT19 trapping by Option ROM: IMMEDIATE – execute the trap right away; POSTONED – execute the trap during legacy boot.
Boot option filter	UEFI and Legacy Legacy only[Default] UEFI only	This option controls Legacy/UEFI ROMs priority.
Network	Do not launch[Default] UEFI Legacy	Controls the execution of UEFI and Legacy PXE OpROM.
Storage	Do not launch UEFI Legacy[Default]	Controls the execution of UEFI and Legacy Storage OpROM.
Video	Do not launch UEFI Legacy[Default]	Controls the execution of UEFI and Legacy Video OpROM.
Other PCI devices	Do not launch UEFI Legacy[Default]	Determines OpROM execution policy for devices other than Network, Storage, or Video.

3.6.2.14 SDIO Configuration

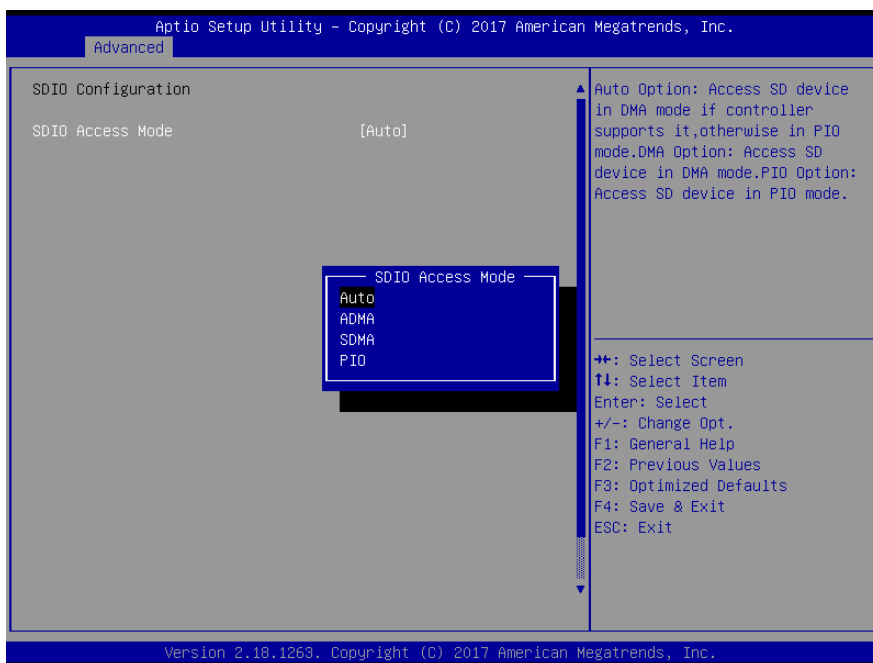

Item	Options	Description
SDIO Access Mode	Auto[Default] ADMA SDMA PIO	Auto Option: Access SD device in DMA mode if controller supports it, otherwise in PIO mode. DMA Option: Access SD device in DMA mode. PIO Option: Access SD device in PIO mode.

3.6.2.15 USB Configuration

The USB Configuration menu helps read USB information and configures USB settings.

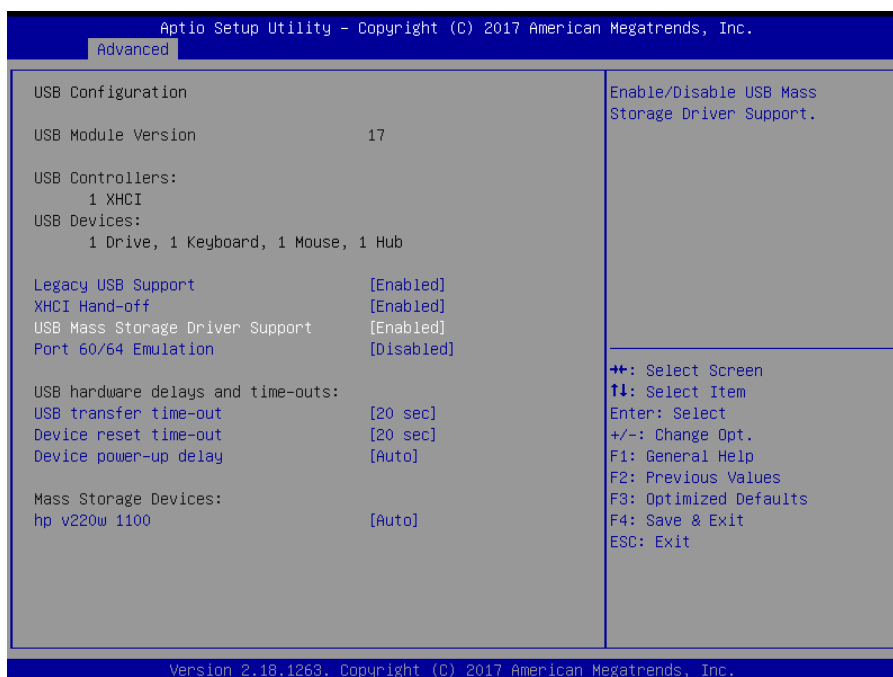

EMX-SKLUP User's Manual

Item	Options	Description
Legacy USB Support	Enabled[Default] Disabled Auto	Enables Legacy USB support. AUTO option disables legacy support if no USB devices are connected. DISABLE option will keep USB devices available only for EFI applications.
XHCI Hand-off	Enabled[Default] Disabled	This is a workaround for OSes without XHCI hand-off support. The XHCI ownership change should be claimed by XHCI driver.
USB Mass Storage Driver Support	Enabled[Default] Disabled	Enable/Disable USB Mass Storage Driver Support.
Port 60/64 Emulation	Enabled Disabled[Default]	Enables I/O port 60h/64h emulation support. This should be enabled for the complete USB keyboard legacy support for non-USB aware OSes.
USB transfer time-out	1 sec 5 sec 10 sec 20 sec[Default]	The time-out value for Control, Bulk, and Interrupt transfers.
Device reset time-out	10 sec 20 sec[Default] 30 sec 40 sec	USB mass storage device Start Unit command time-out.
Device power-up delay	Auto[Default] Manual	Maximum time the device will take before it properly reports itself to the Host Controller. 'Auto' uses default value: for a Root port it is 100ms, for a Hub port the delay is taken from Hub descriptor.
Mass Storage Devices	Auto[Default] Floppy Forced FDD Hard Disk CD-ROM	Mass storage device emulation type. 'AUTO' enumerates devices according to their media format. Optical drives are emulated as 'CDROM', drives with no media will be emulated according to a drive type.

3.6.3 Chipset

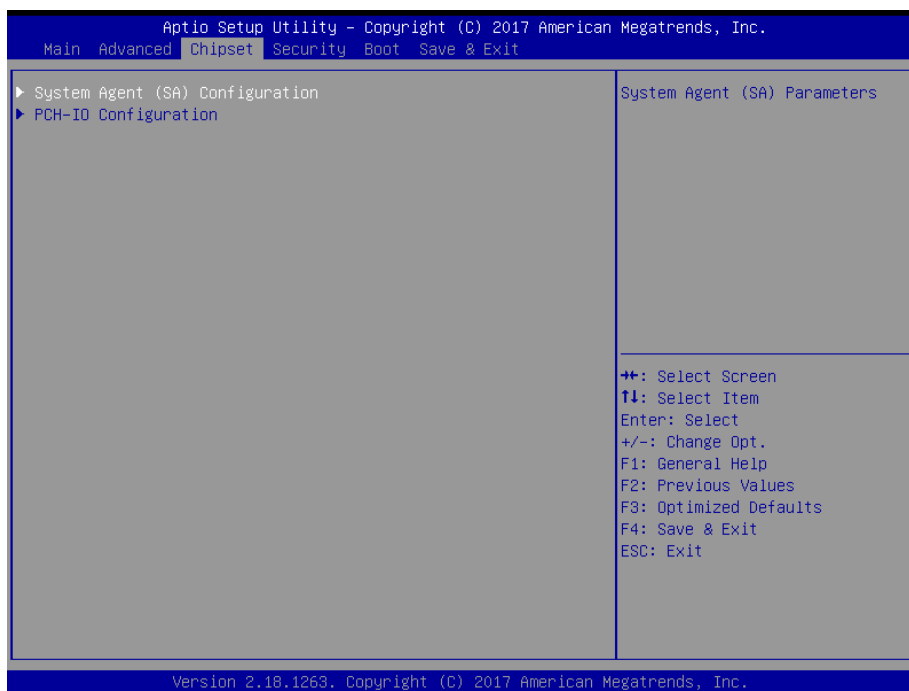

3.6.3.1 System Agent (SA) Configuration



Item	Option	Description
VT-d	Enabled[Default] Disabled	VT-d capability.

3.6.3.1.1 Graphics Configuration

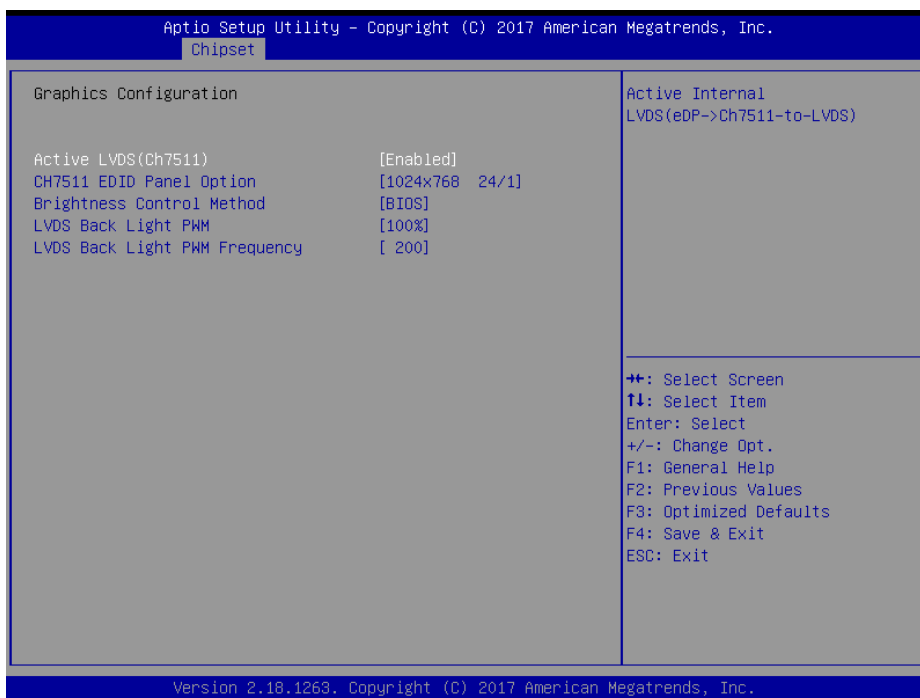

Item	Option	Description
Active LVDS(CH7511)	Enabled[Default] Disabled	Active Internal LVDS(eDP->Ch7511-to-LVDS).
CH7511 EDID Panel Option	1024x768 24/1[Default] 800x600 18/1 1024x768 18/1 1366x768 18/1 1024x600 18/1 1280x800 18/1 1920x1200 24/2 1920x1080 18/2 1280x1024 24/2 1440x900 18/2 1600x1200 24/2 1366x768 24/1 1920x1080 24/2 1680x1050 24/2	Port1-EDP to LVDS (Chrotel 7511) Panel EDID Option.
Brightness Control Method	BIOS[Default] BR Button VR OS driver	LVDS Brightness Control Method. 1.BIOS 2.Brightness Button 3.Variable Resistor 4.OS Driver.
LVDS Back Light PWM	00% 25% 50% 75% 100%[Default]	Select LVDS back light PWM duty.

LVDS Back Light PWM Frequency	200 [Default]	Select LVDS back light PWM Frequency.
	300	
	400	
	500	
	700	
	1k	
	2k	
	3k	
	5k	
	10k	
20k		

3.6.3.1.2 Memory Configuration



Item	Option	Description
Max TOLUD	Dynamic [Default] /1GB/1.25GB/1.5GB/1.75GB /2GB/2.25GB/2.5GB/2.75GB	Maximum Value of TOLUD. Dynamic assignment would adjust TOLUD automatically based on largest MMIO length of installed graphic controller.

EMX-SKLUP User's Manual

3.6.3.2 PCH-IO Configuration

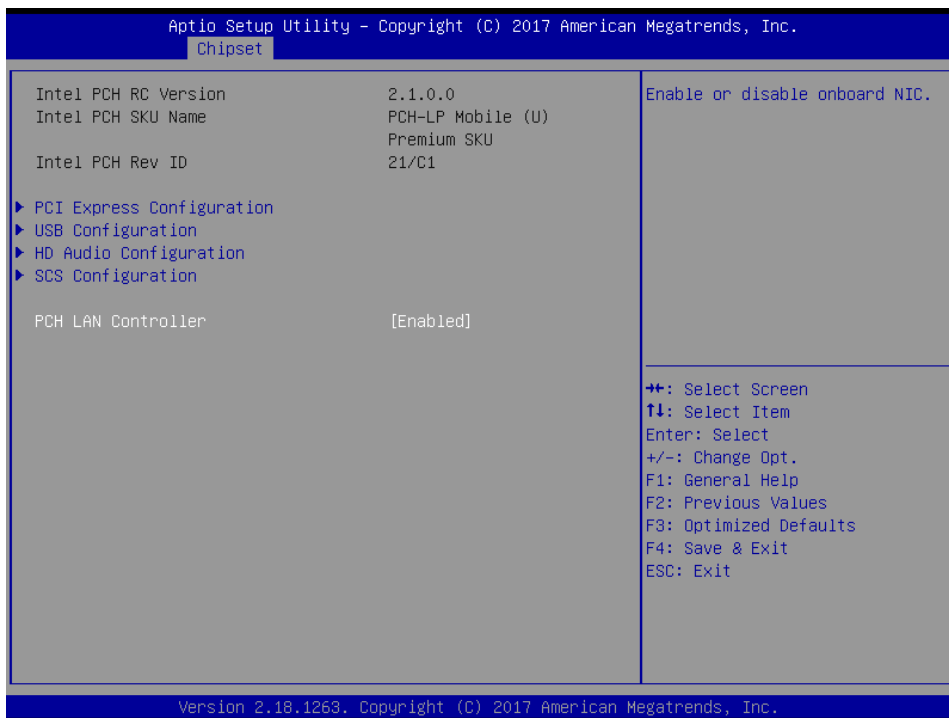

Item	Option	Description
PCH LAN Controller	Disabled Enabled[Default]	Enable or disable onboard NIC.

3.6.3.2.1 PCI Express Configuration

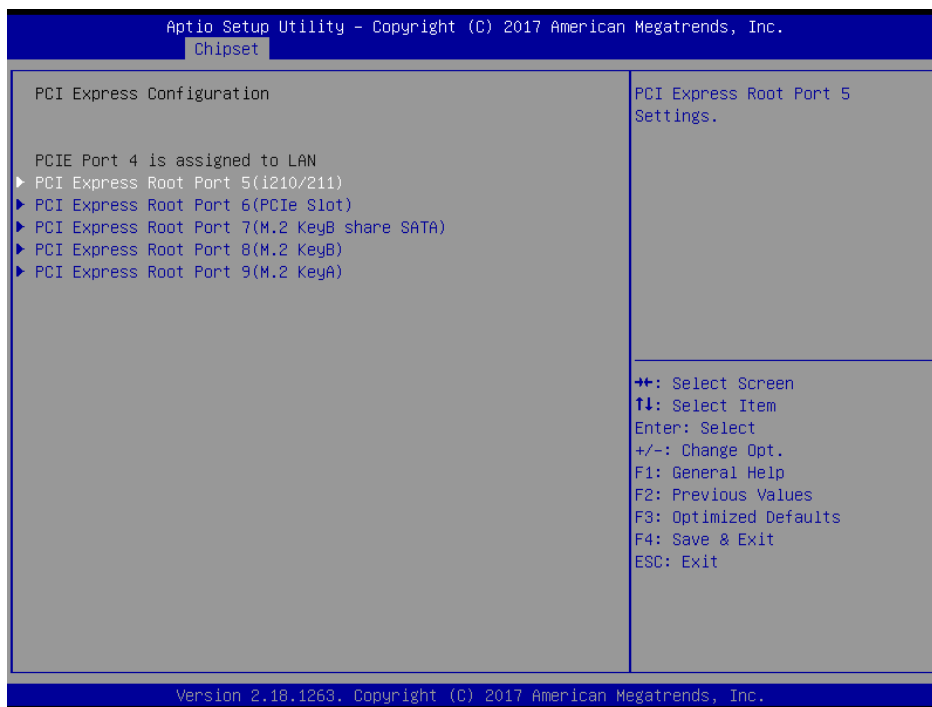

3.6.3.2.1.1 PCI Express Root Port 5 (i210/211)

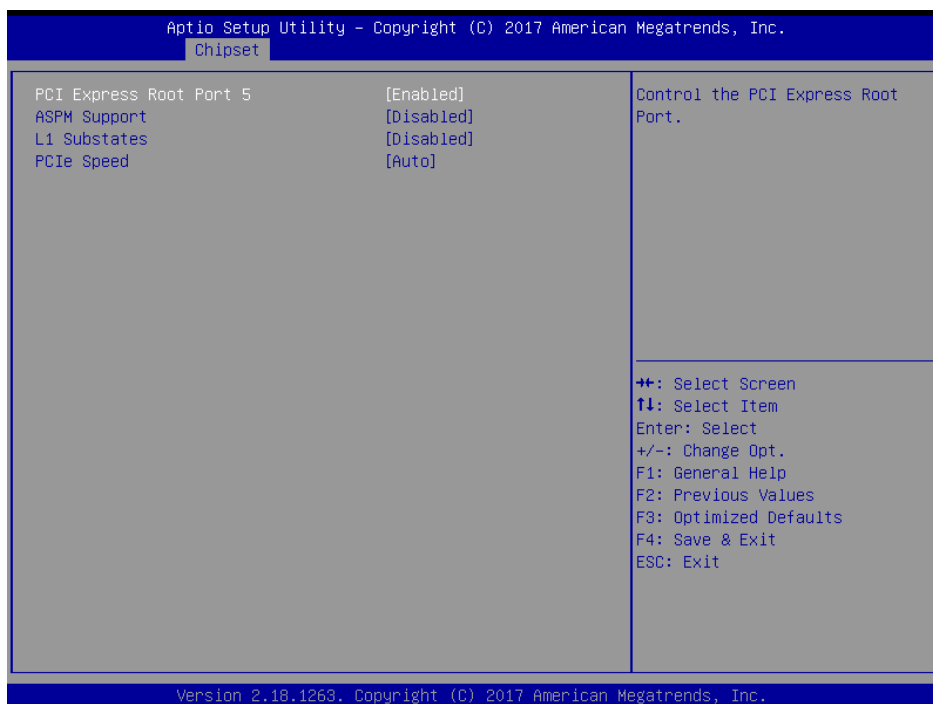

Item	Option	Description
PCI Express Root Port 5	Enabled[Default], Disabled	Control the PCI Express Root Port.
ASPM Support	Disabled[Default] L0s L1 L0sL1 Auto,	Set the ASPM Level: Force L0s – Force all links to L0s State AUTO – BIOS auto configure DISABLE – Disables ASPM.
L1 Substates	Disabled[Default] L1.1 L1.2 L1.1 & L1.2,	PCI Express L1 Substates settings.
PCIe Speed	Auto[Default] Gen1 Gen2 Gen3	Select PCI Express port speed.

3.6.3.2.1.2 PCI Express Root Port 6 (PCIe Slot)

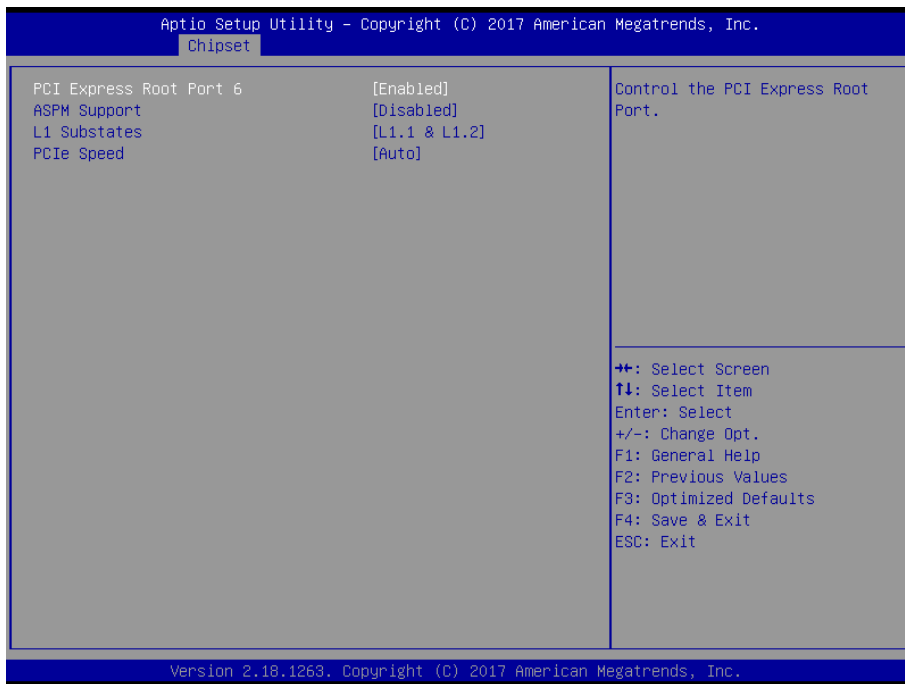

Item	Option	Description
PCI Express Root Port 6	Enabled[Default], Disabled	Control the PCI Express Root Port.
ASPM Support	Disabled[Default] L0s L1 L0sL1 Auto,	Set the ASPM Level: Force L0s – Force all links to L0s State AUTO – BIOS auto configure DISABLE – Disables ASPM.
L1 Substates	Disabled L1.1 L1.2 L1.1 & L1.2[Default]	PCI Express L1 Substates settings.
PCIe Speed	Auto[Default] Gen1 Gen2 Gen3	Select PCI Express port speed.

3.6.3.2.1.3 PCI Express Root Port 7 (M.2 KeyB share SATA)

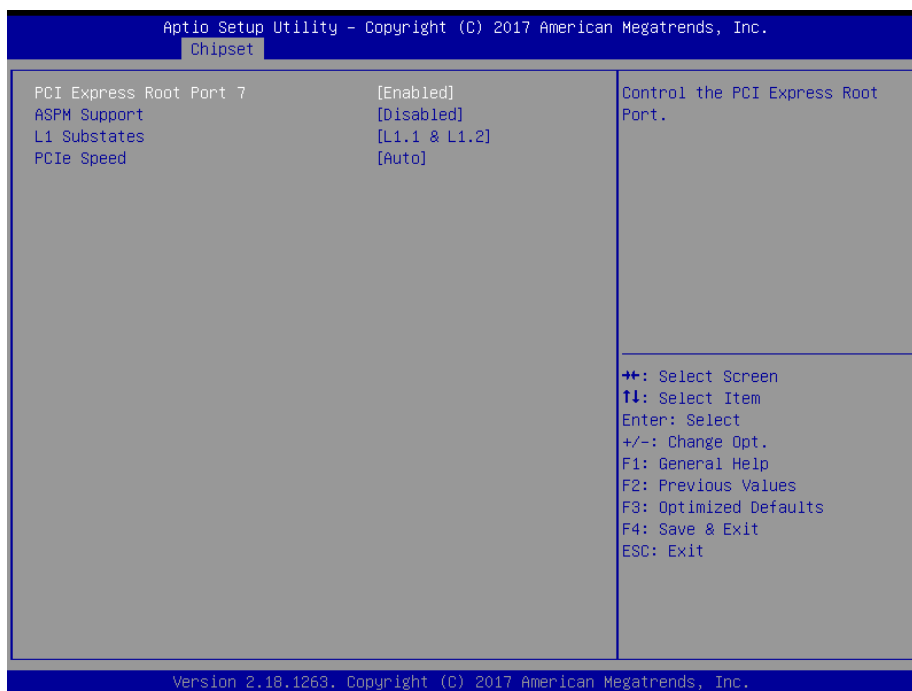

Item	Option	Description
PCI Express Root Port 7	Enabled[Default], Disabled	Control the PCI Express Root Port.
ASPM Support	Disabled[Default] L0s L1 L0sL1 Auto,	Set the ASPM Level: Force L0s – Force all links to L0s State AUTO – BIOS auto configure DISABLE – Disables ASPM.
L1 Substates	Disabled L1.1 L1.2 L1.1 & L1.2[Default]	PCI Express L1 Substates settings.
PCIe Speed	Auto[Default] Gen1 Gen2 Gen3	Select PCI Express port speed.

3.6.3.2.1.4 PCI Express Root Port 8 (M.2 KeyB)

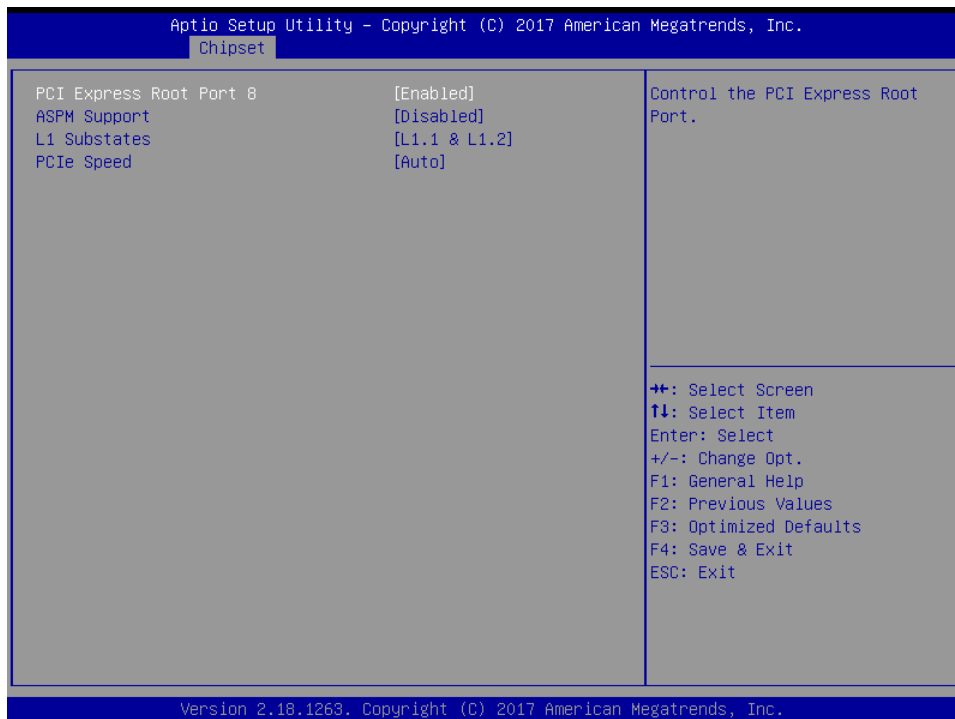

Item	Option	Description
PCI Express Root Port 8	Enabled[Default], Disabled	Control the PCI Express Root Port.
ASPM Support	Disabled[Default] L0s L1 L0sL1 Auto,	Set the ASPM Level: Force L0s – Force all links to L0s State AUTO – BIOS auto configure DISABLE – Disables ASPM.
L1 Substates	Disabled L1.1 L1.2 L1.1 & L1.2[Default]	PCI Express L1 Substates settings.
PCIe Speed	Auto[Default] Gen1 Gen2 Gen3	Select PCI Express port speed.

3.6.3.2.1.5 PCI Express Root Port 9 (M.2 KeyA)

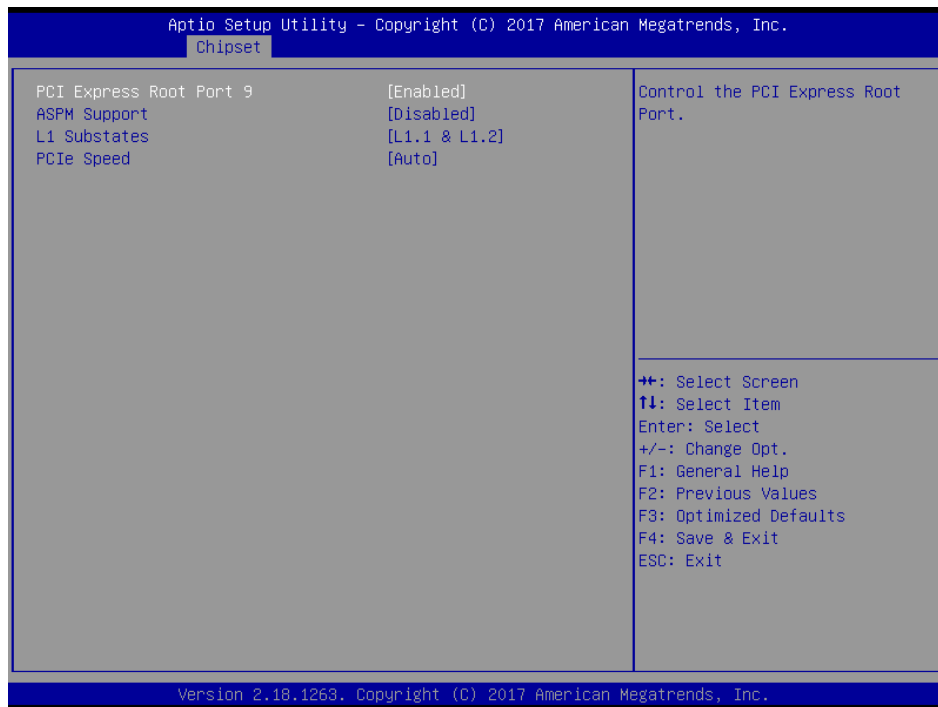

Item	Option	Description
PCI Express Root Port 9	Enabled[Default], Disabled	Control the PCI Express Root Port.
ASPM Support	Disabled[Default] L0s L1 L0sL1 Auto,	Set the ASPM Level: Force L0s – Force all links to L0s State AUTO – BIOS auto configure DISABLE – Disables ASPM.
L1 Substates	Disabled L1.1 L1.2 L1.1 & L1.2[Default]	PCI Express L1 Substates settings.
PCIe Speed	Auto[Default] Gen1 Gen2 Gen3	Select PCI Express port speed.

3.6.3.2.2 USB Configuration

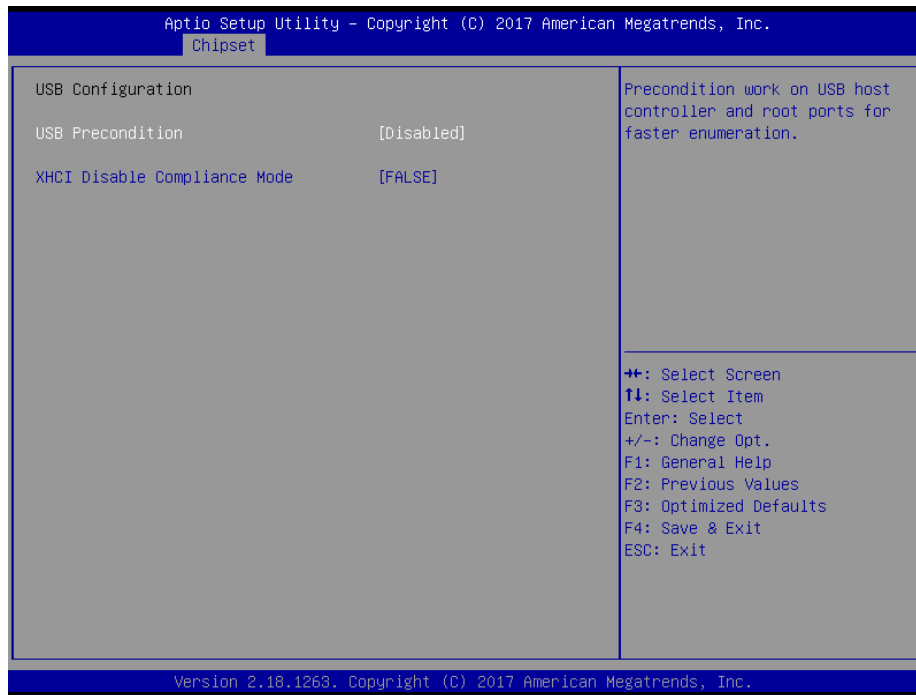

Item	Option	Description
USB Precondition	Enabled Disabled [Default] ,	Precondition work on USB host controller and root ports for faster enumeration.
XHCI Disable Compliance Mode	FALSE[Default] , TRUE	Option to disable Compliance Mode. Default is FALSE to not disable Compliance Mode. Set TRUE to disable Compliance Mode.

3.6.3.2.3 HD Audio Configuration



Item	Option	Description
HD Audio	Disabled Enabled Auto[Default],	Control Detection of the HD-Audio device. Disable = HDA will be unconditionally disabled Enabled = HDA will be unconditionally enabled Auto = HDA will be enabled if present, disabled otherwise.
Amplifier Gain	20db[Default] 26db 32db 36db	Amplifier Gain.

3.6.3.2.4 SCS Configuration

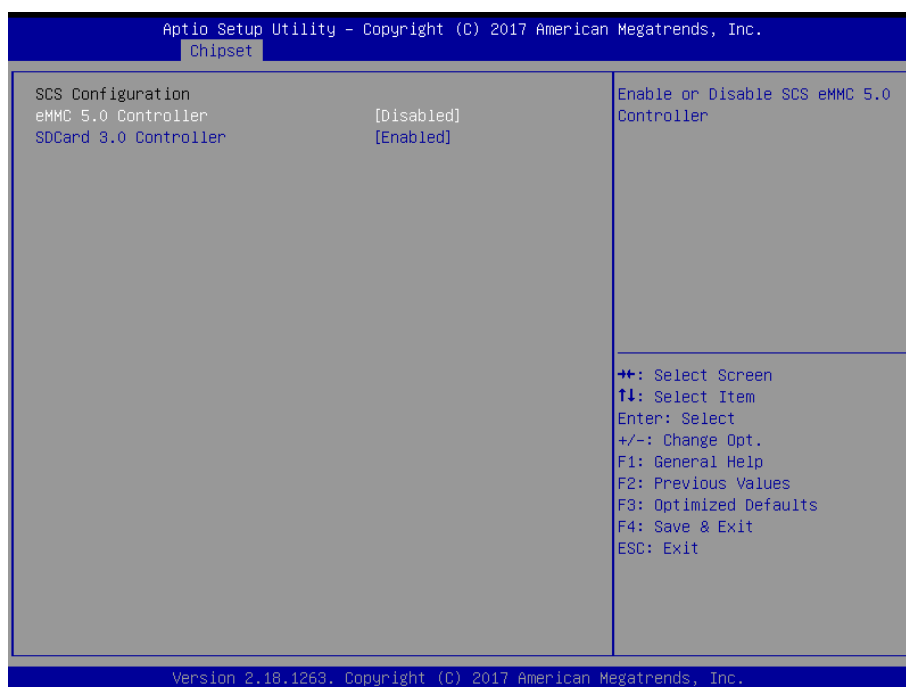

Item	Option	Description
eMMC 5.0 Controller	Disabled[Default] Enabled	Enable or Disable SCS eMMC 5.0 Controller.
SDCard 3.0 Controller	Disabled Enabled[Default]	Enable or Disable SCS SDHC 3.0 Controller.

3.6.4 Security

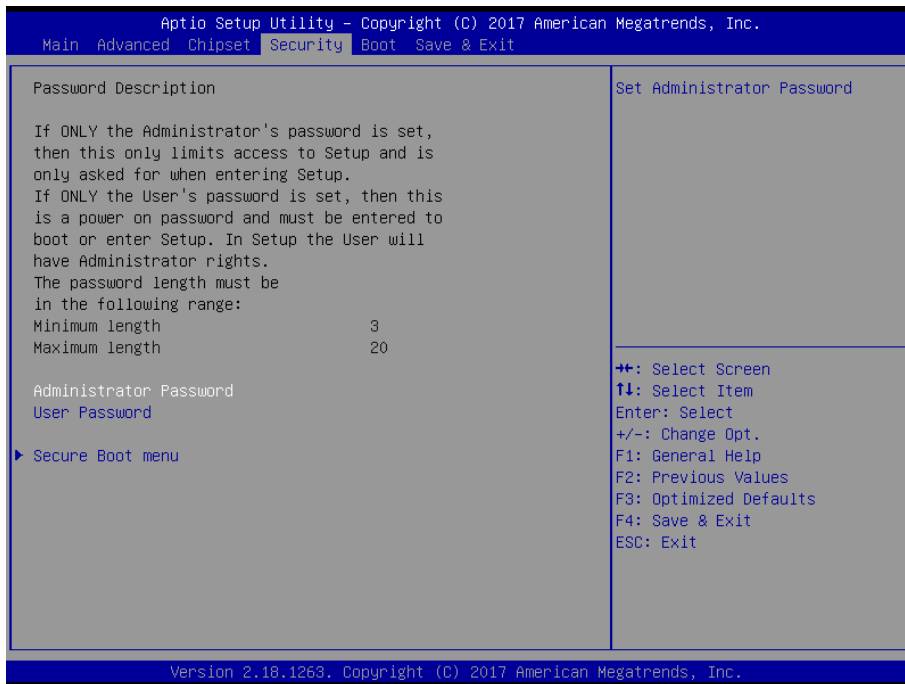

- **Administrator Password**

Set setup Administrator Password

- **User Password**

Set User Password

3.6.4.1 Secure Boot menu

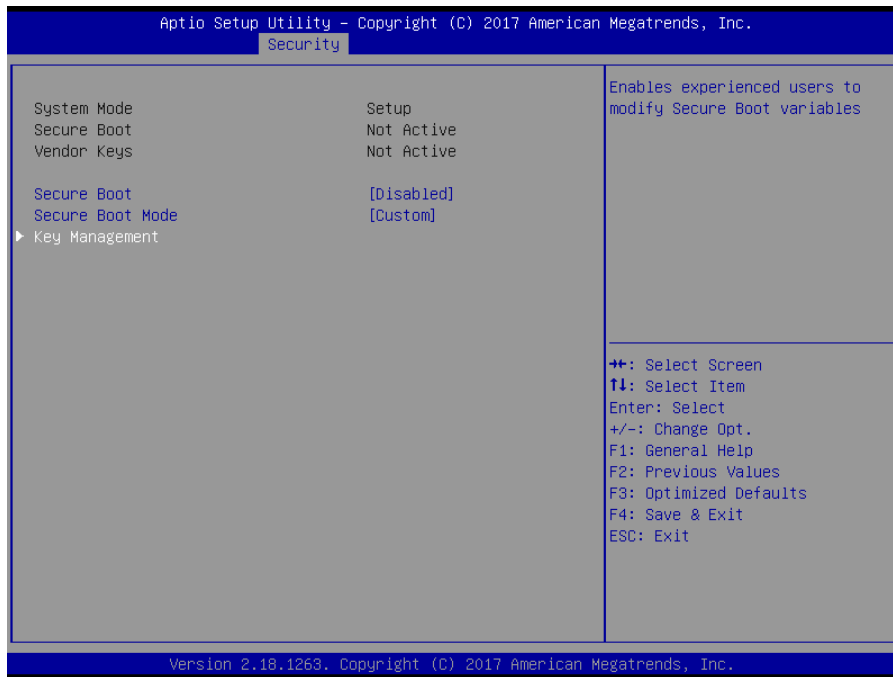

Item	Option	Description
Secure Boot	Disabled [Default] Enabled	Secure Boot can be enabled if 1.System running in User mode with enrolled Platform Key(PK) 2.CSM function is disabled.
Secure Boot Mode	Standard Custom [Default]	Secure Boot mode selector. 'Custom' Mode enables users to change Image Execution policy and manage Secure Boot Keys.

3.6.4.1.1 Key Management

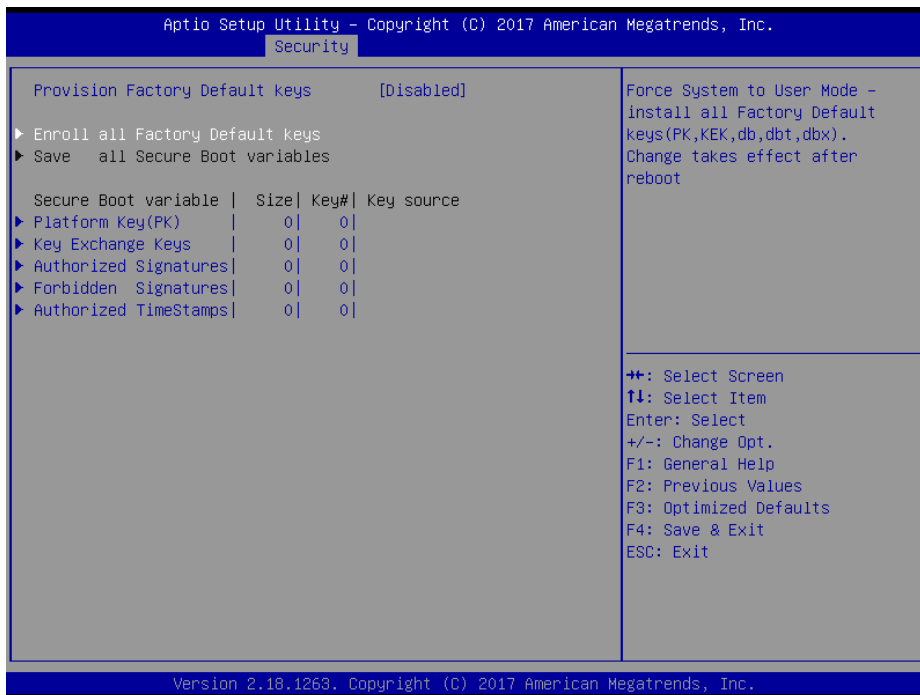

Item	Option	Description
Provision Factory Default keys	Disabled[Default] Enabled	Install factory default Secure Boot keys when System is in Setup Mode.

3.6.5 Boot

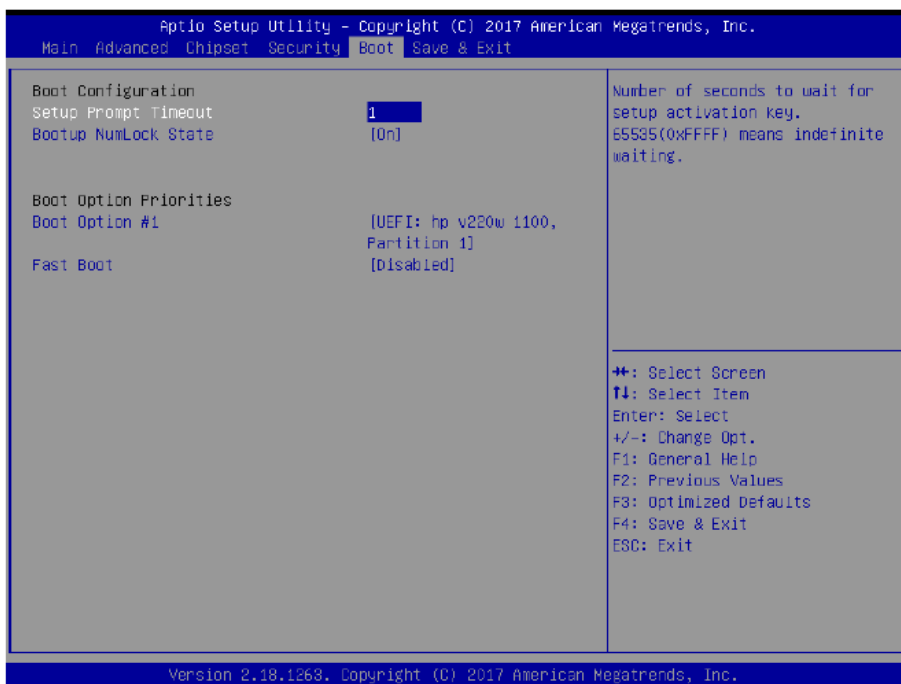

Item	Option	Description
Setup Prompt Timeout	1~ 65535	Number of seconds to wait for setup activation key. 65535(0xFFFF) means indefinite waiting.
Bootup NumLock State	On[Default] Off	Select the Keyboard NumLock state
Fast Boot	Disabled[Default] Enabled	Enables or disables boot with initialization of a minimal set of devices required to launch active boot option. Has no effect for BBS boot options.
Boot Option #1	Set the system boot order.	

3.6.6 Save and exit



3.6.6.1 Save Changes and Reset

Reset the system after saving the changes.

3.6.6.2 Discard Changes and Reset

Reset system setup without saving any changes.

3.6.6.3 Restore Defaults

Restore/Load Default values for all the setup options.

3.6.6.4 Launch EFI Shell from filesystem device

Attempts to Launch EFI Shell application (Shell.efi) from one of the available filesystem devices.

4. Drivers Installation



Note: Installation procedures and screen shots in this section are for your reference and may not be exactly the same as shown on your screen.

4.1 Install Chipset Driver

All drivers can be found on the Avalue Official Website:

<http://www.avalue.com.tw>.



Note: The installation procedures and screen shots in this section are based on Windows 10 operation system. If the warning message appears while the installation process, click Continue to go on.

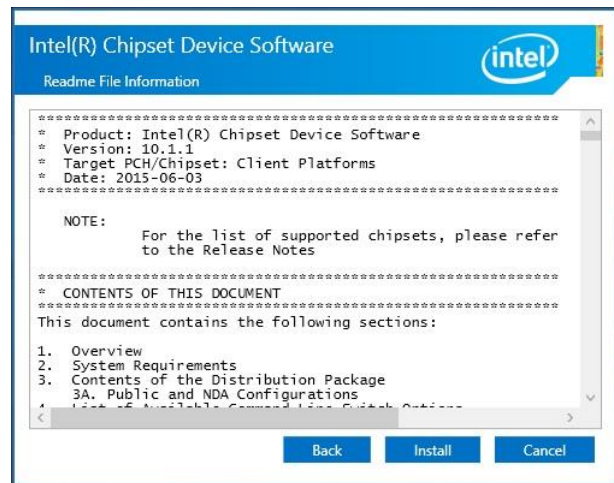

Step 3. Click Install.



Step1. Click Next.



Step 4. Complete setup.



Step 2. Click Accept.

4.2 Install VGA Driver

All drivers can be found on the Avalue Official Website:

<http://www.avalue.com.tw>.



Note: The installation procedures and screen shots in this section are based on Windows 10 operation system. If the warning message appears while the installation process, click Continue to go on.

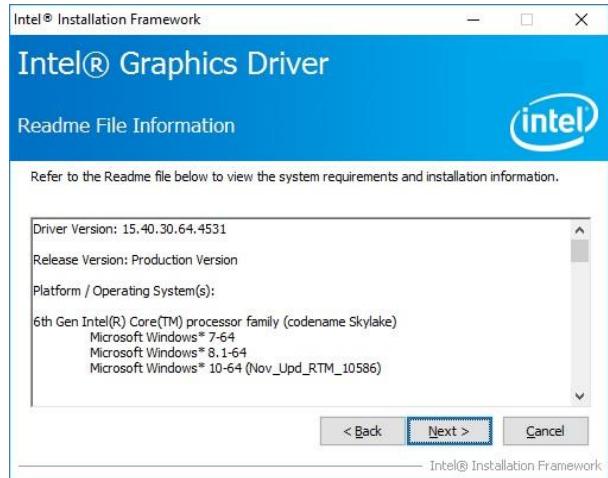

Step 3. Click Next.

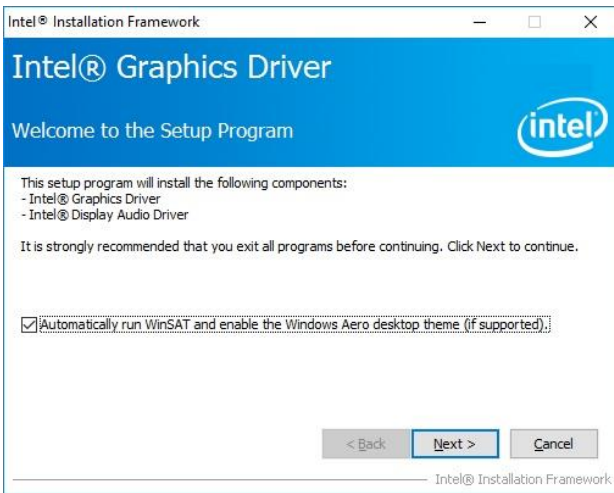

Step 1. Click Next to continue installation.

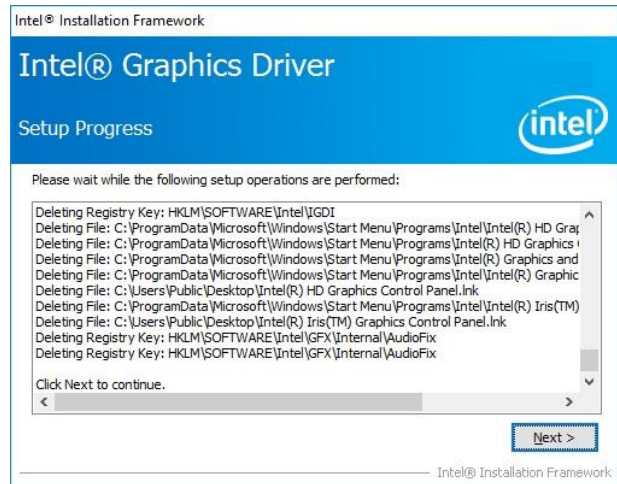

Step 4. Click Next.

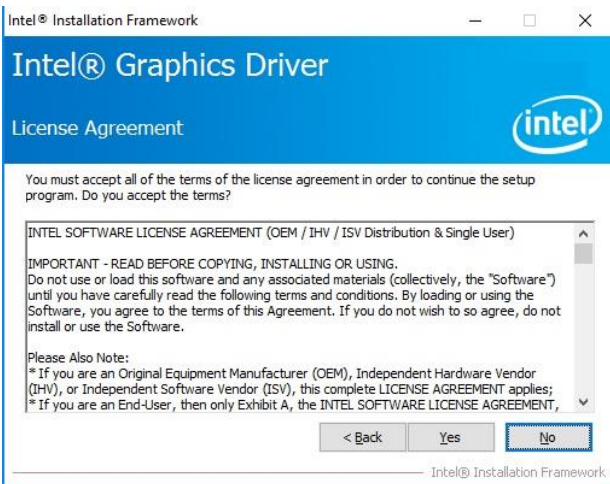

Step 2.

Click **Yes** to accept license agreement.

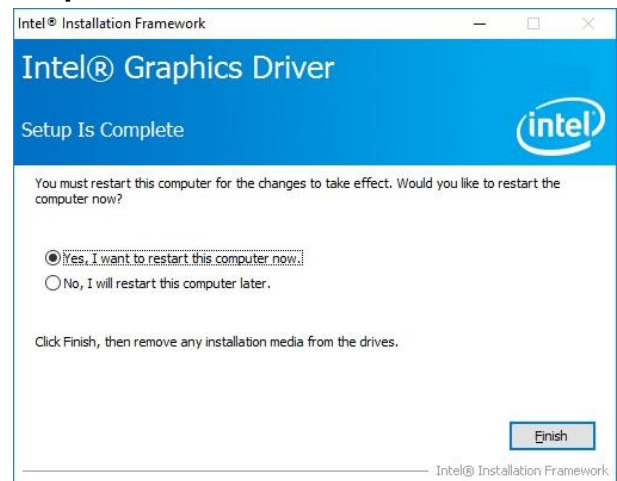

Step 5. Click Finish to complete setup.

4.3 Install Serial IO Driver

All drivers can be found on the Avalue Official Website:
<http://www.avalue.com.tw>.



Note: The installation procedures and screen shots in this section are based on Windows 10 operation system. If the warning message appears while the installation process, click Continue to go on.

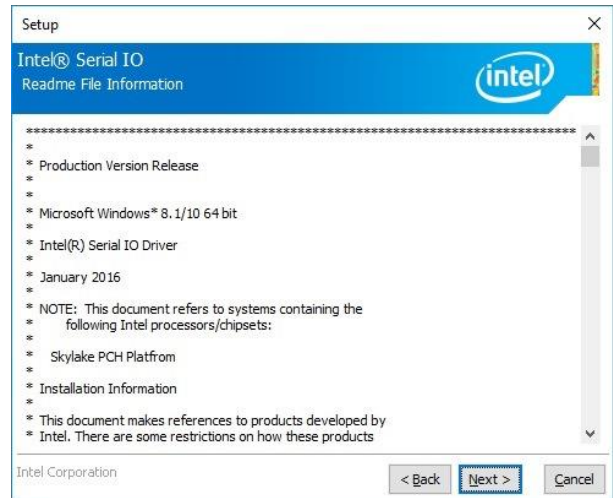

Step 3. Click Next.

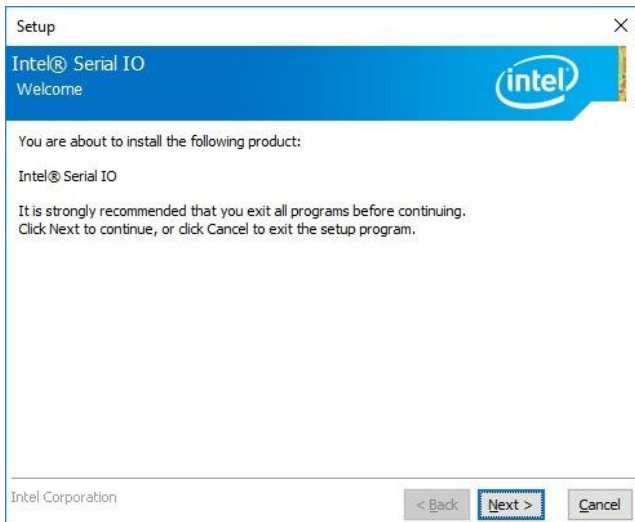

Step 1. Click Next to continue installation.

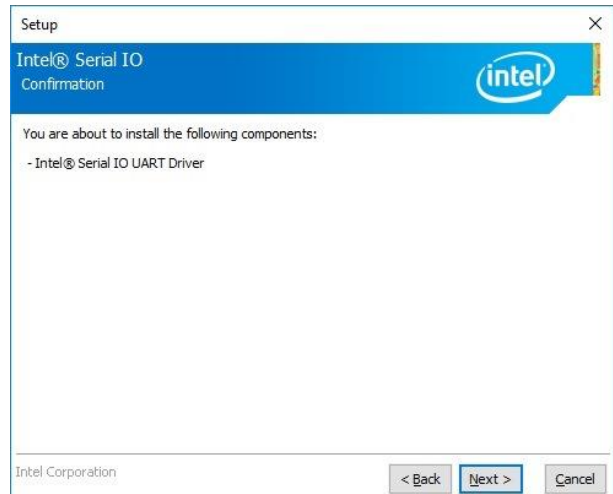

Step 4. Click Next.



Step 2. Click Next.

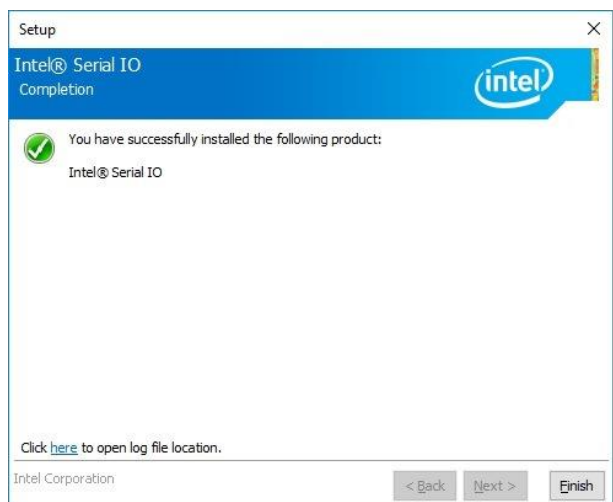

Step 5. Click Finish to complete setup.

4.4 Install ME Driver

All drivers can be found on the Avalue Official Website:

<http://www.avalue.com.tw>.



Note: The installation procedures and screen shots in this section are based on Windows 10 operation system. If the warning message appears while the installation process, click Continue to go on.

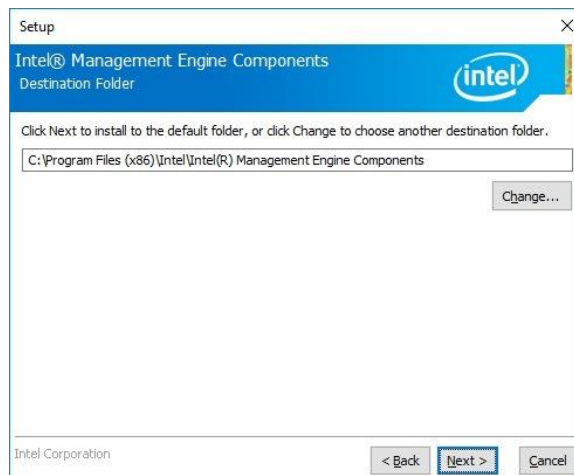

Step 3. Click Next.

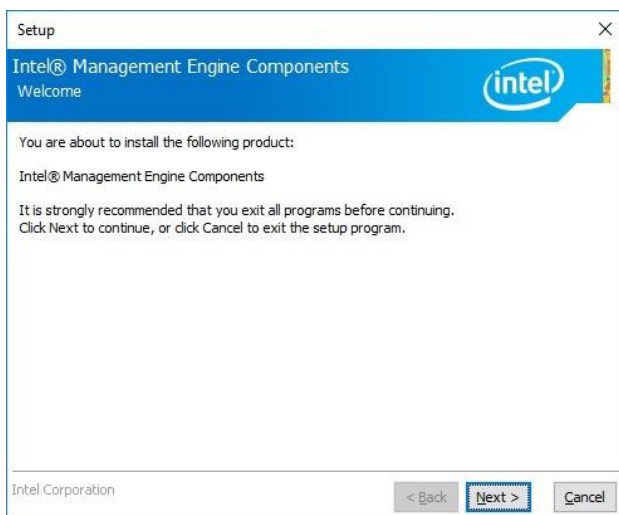

Step 1. Click Next to continue setup.



Step 2. Click Next.



Step 4. Click Finish to complete setup.

4.5 Install Audio Driver (For Realtek ALC888S HD Audio)

All drivers can be found on the Avalue Official Website:

<http://www.avalue.com.tw>.



Note: The installation procedures and screen shots in this section are based on Windows 10 operation system. If the warning message appears while the installation process, click Continue to go on.

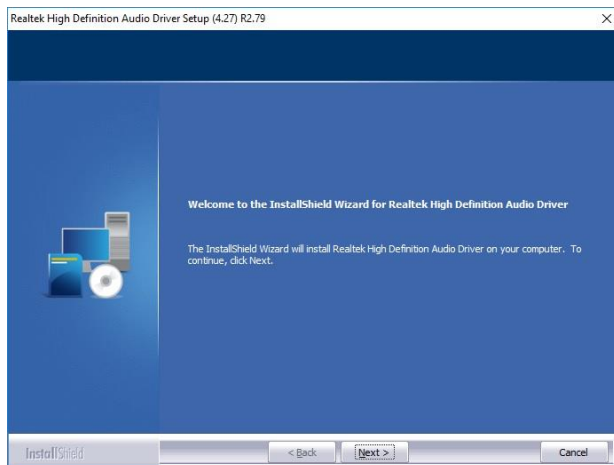

Step1. Click **Next** to Install.

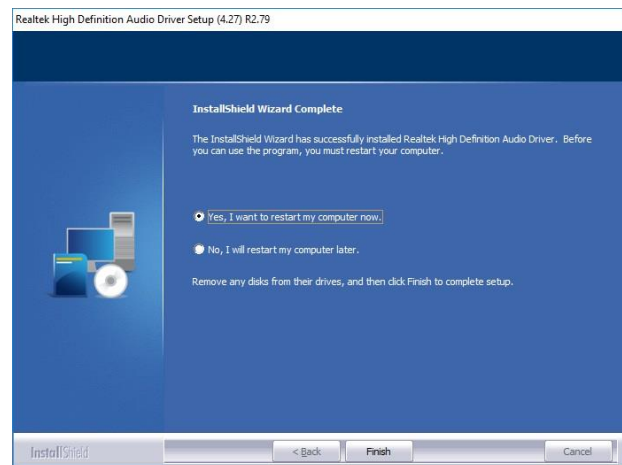

Step 2. Click **Finish** to complete setup.

4.6 Install LAN Driver

All drivers can be found on the Avalue Official Website:

<http://www.avalue.com.tw>.



Note: The installation procedures and screen shots in this section are based on Windows 10 operation system. If the warning message appears while the installation process, click Continue to go on.

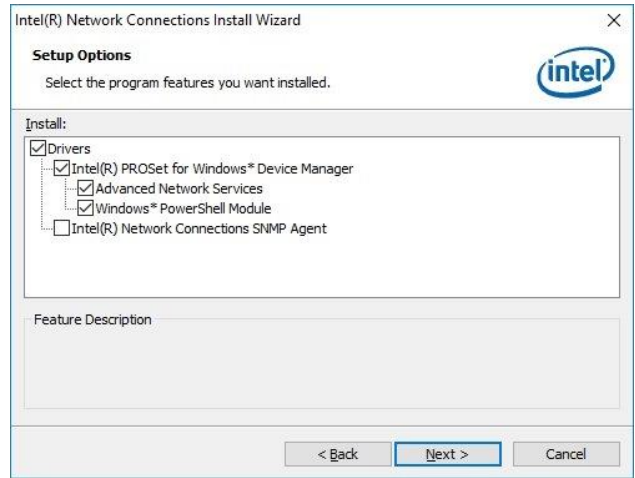

Step 3. Click Next.

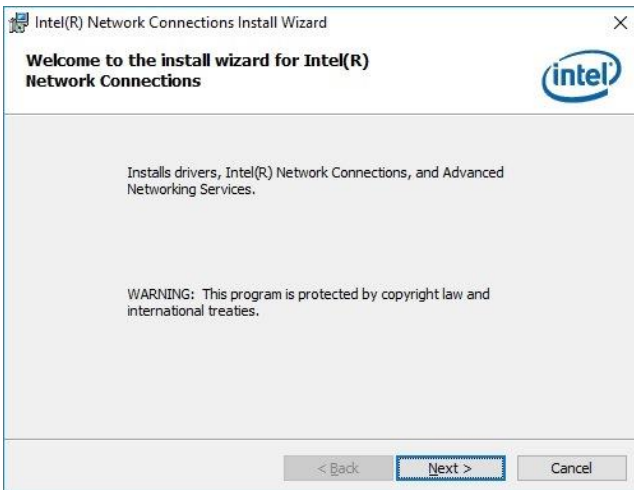

Step 1. Click Next to continue installation.

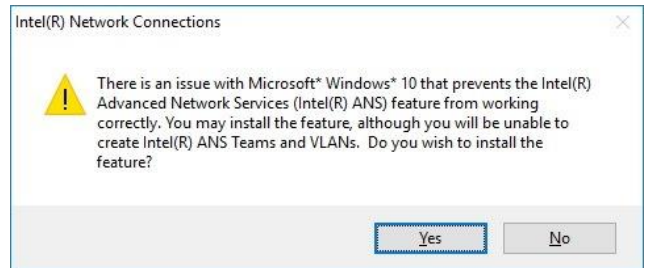

Step 4. Click Yes.

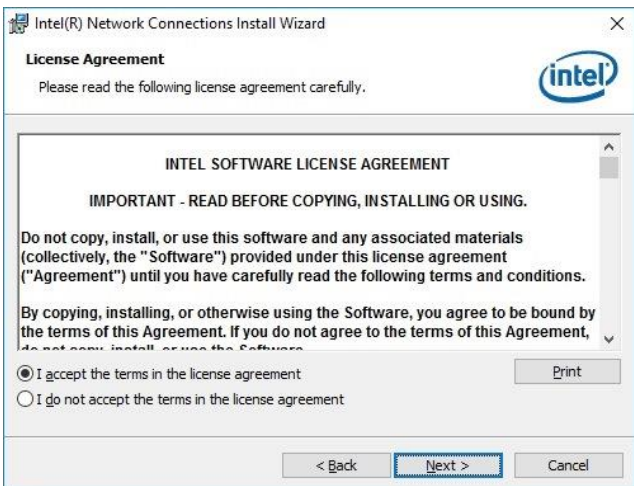

Step 2. Click Next.

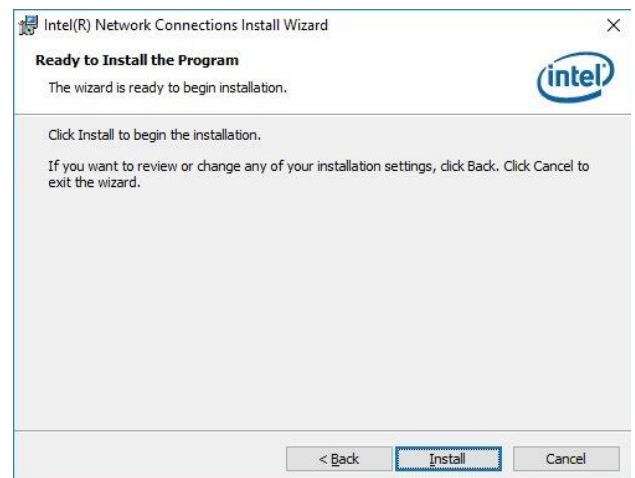

Step 5. Click Install.

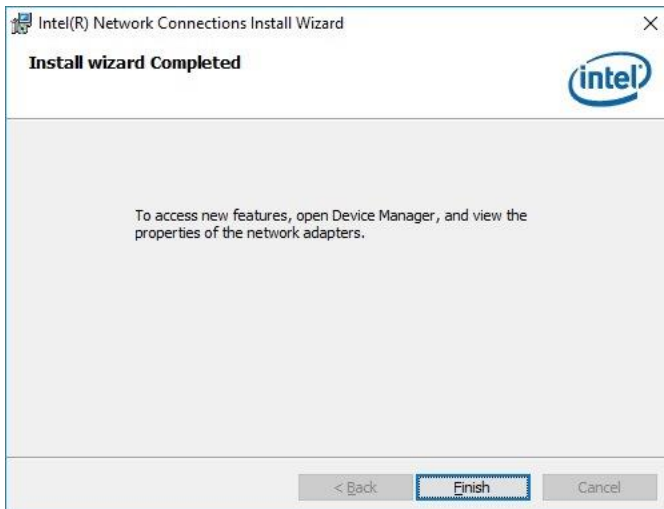

Step 6. Click **Finish** to complete setup.

4.7 Install RST Driver

All drivers can be found on the Avalue Official Website:

<http://www.avalue.com.tw>.



Note: The installation procedures and screen shots in this section are based on Windows 10 operation system. If the warning message appears while the installation process, click Continue to go on.

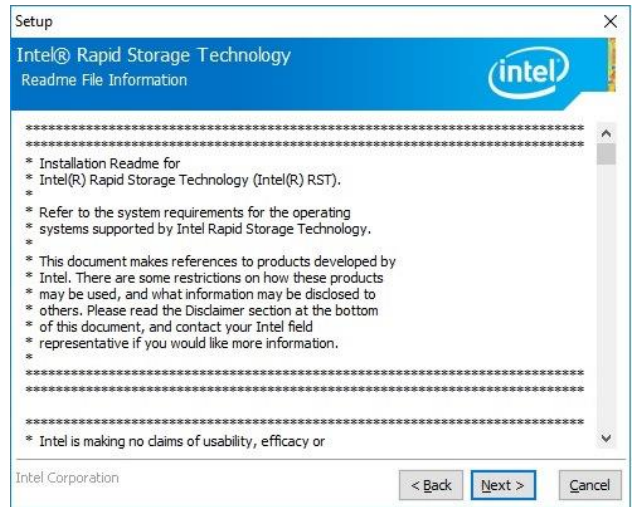

Step 3. Click Next.

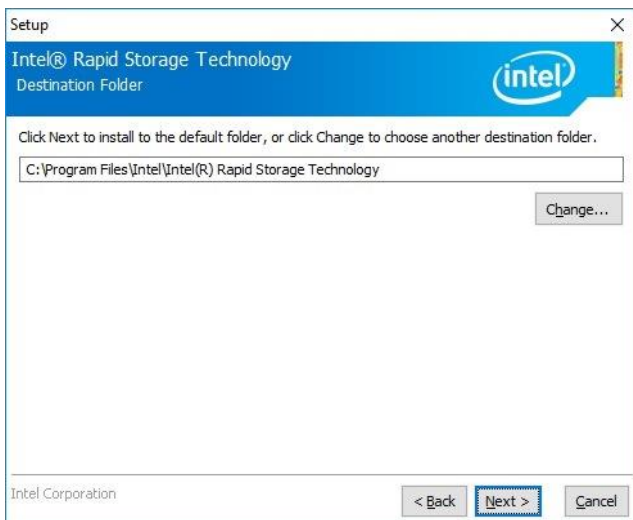
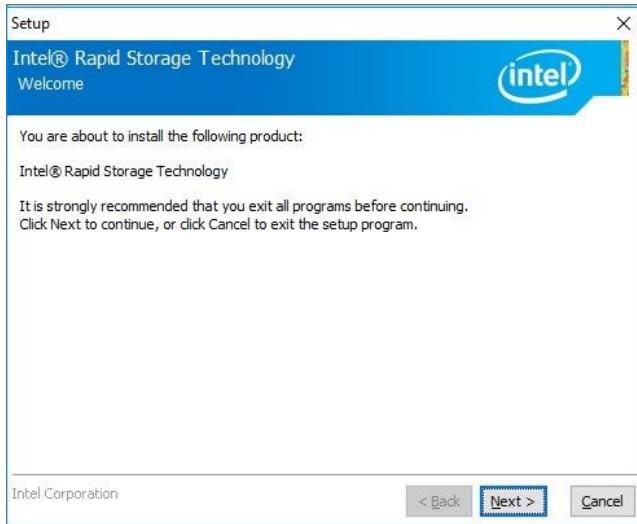

Step 1. Click Next to continue installation.

Step 4. Click Next.

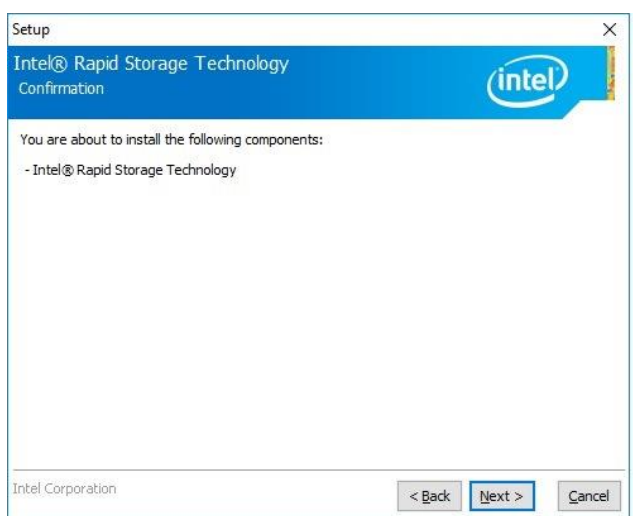
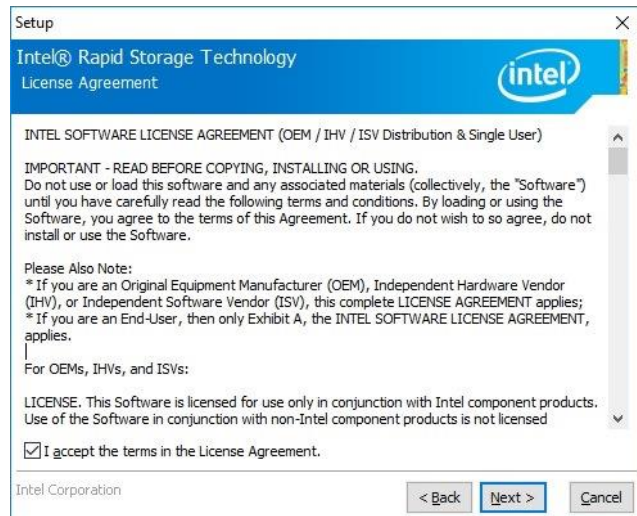

Step 2. Click Next.

Step 5. Click Next.



Step 6. Click **Finish** to complete setup.

5. Mechanical Drawing



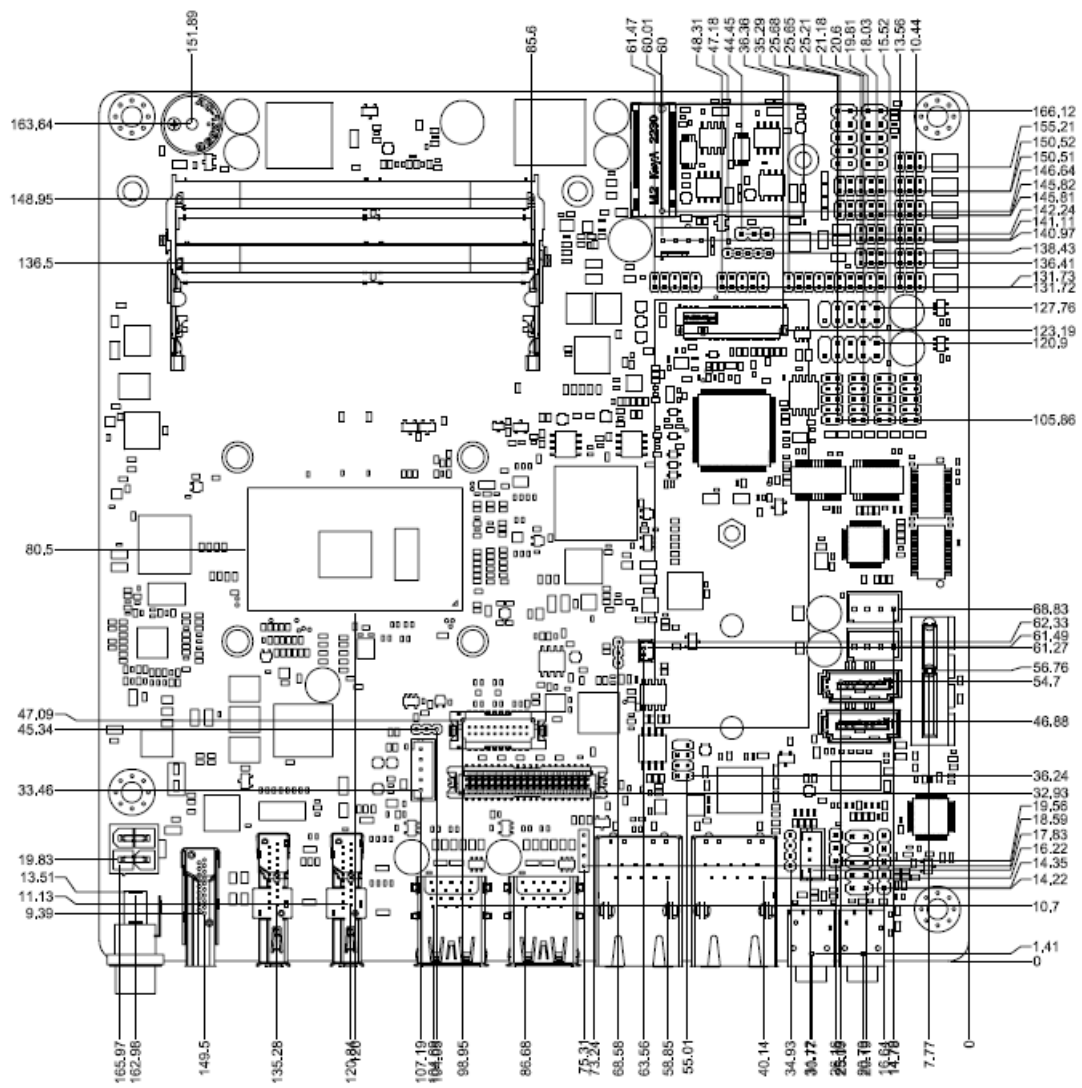

Unit: mm

EMX-SKLUP User's Manual

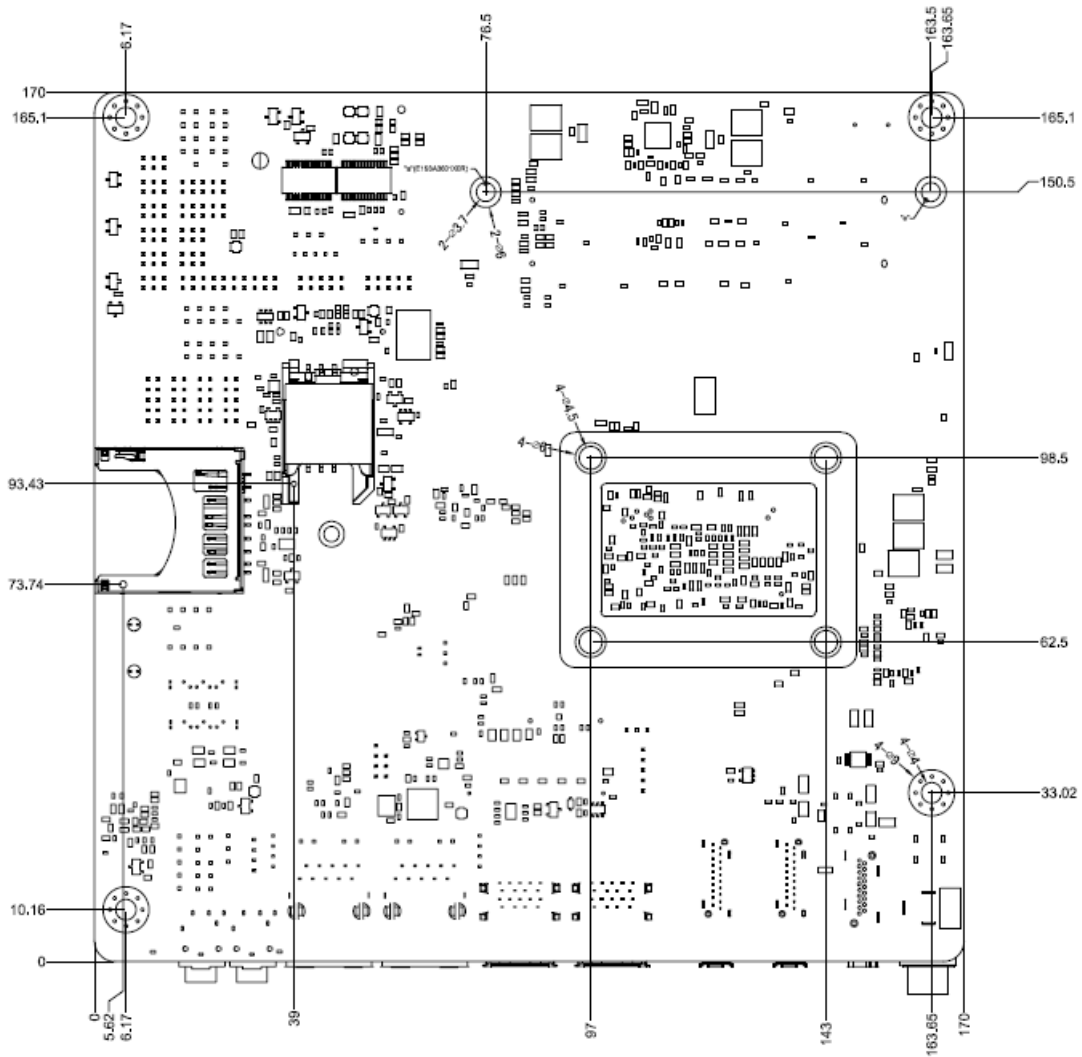

Unit: mm

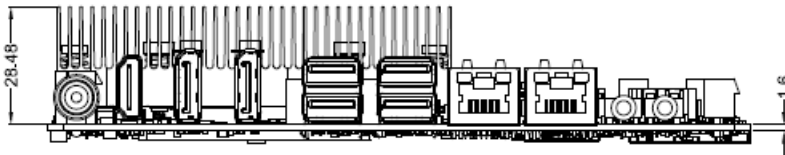
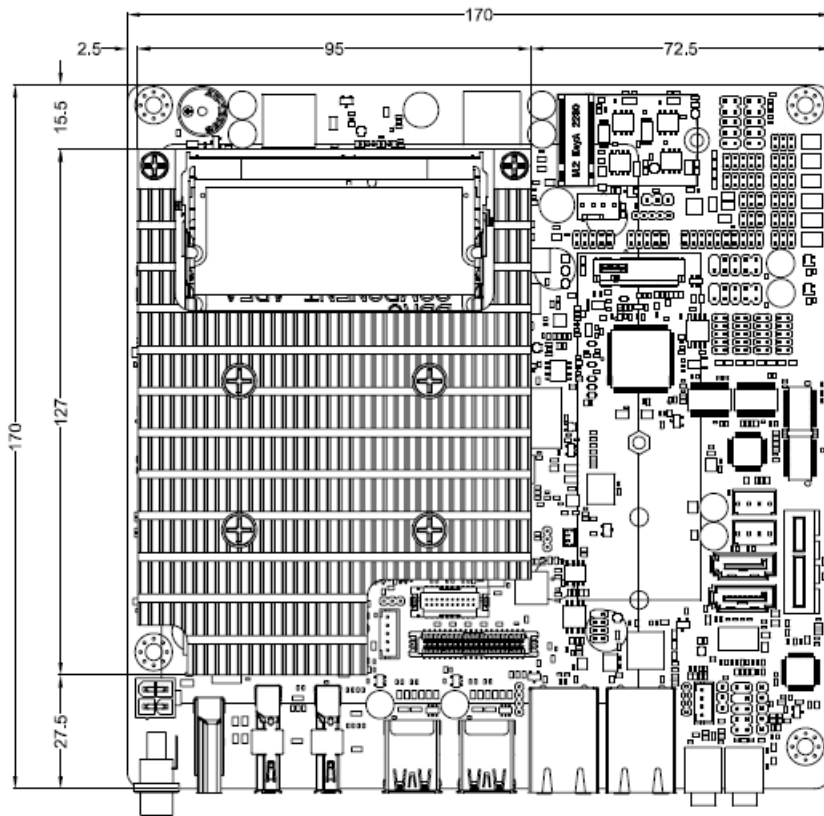

Unit: mm

EMX-SKLUP User's Manual

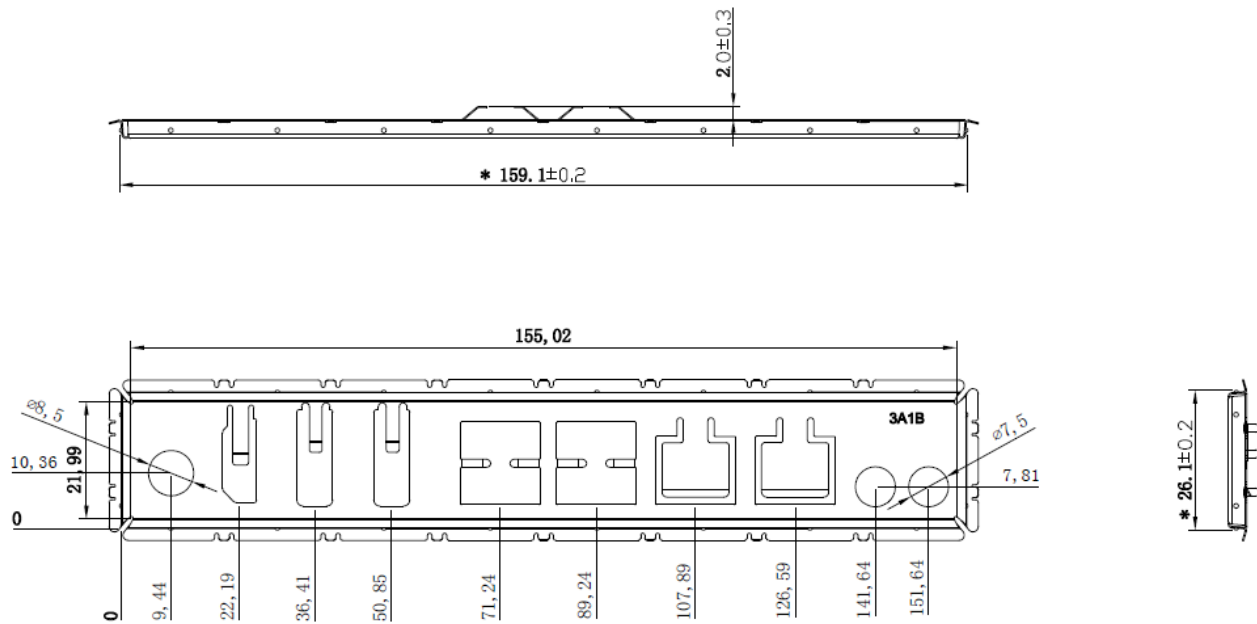

Unit: mm

